

CLOSED CIRCUIT COOLERS

LSWE/LRWB

Forced Draft Closed Circuit Coolers



LSWE



LRWB



*Mark owned by the Cooling Technology Institute



Get to Know EVAPCO

- The global innovator in heat transfer solutions
- Serving the commercial HVAC, Industrial Refrigeration, Power Generation, and Industrial Processing markets
- Founded in 1976
- Employee-owned
- 22 manufacturing facilities in 10 countries
- More than 170 sales offices worldwide

Learn More Now

Visit www.evapco.eu to download product catalogs, view complete product specifications, and more.

EVAPCO is more than a name.

It is a pledge to make everyday life easier, more comfortable, more reliable, and more sustainable for people everywhere. How do we fulfill that promise? It's simple.

We never stop innovating.

At EVAPCO, we do not just talk about innovation, it is ingrained in our workflow. Guided by our annually developed R&D plans, we set out to find groundbreaking solutions that transform the way the world works for the better. It is why we have more than 28 patents worldwide in the last 10 years alone.

We craft exceptionally built solutions.

As an employee-owned company, we take pride in our work. We are proud to be one of the most experienced teams of engineers and craftsmen in the industry. This translates into solutions that are always exceptionally built. EVAPCO has an unwavering commitment to provide "best in class" heat transfer solutions and services.

We guarantee performance.

Every EVAPCO solution is put through rigorous research and testing to ensure maximum efficiency and reliability. But we do not stop there. EVAPCO is an industry leader in independent, third-party performance certifications. These certifications guarantee our performance metrics—so that you can plan your projects with complete peace of mind.

We protect the environment.

Innovation and environmental sustainability go hand-in-hand at EVAPCO. EVAPCO's industrial heat transfer equipment not only conserves natural resources and helps reduce noise pollution, they also feature recycled steel content in their construction. Our stainless steel units are constructed of panels that contain up to 75% recycled content; over 80% in galvanized units construction. From sound reduction to water conservation to chemical elimination, we are constantly developing new technologies that deliver the ultimate operating advantages for our clients— and protect the planet for every generation that comes after us.



Table of Contents

Corporate	2
LSWE and LRWB Principle of Operation	4
Application Versatility	5
LSWE Design and Construction Features	6-7
LRWB Design and Construction Features	8-9
Innovative Design Features	10-11
Water Treatment Solutions	12-13
LSWE Stainless Steel Options	14
LRWB Stainless Steel Options	15
Coil Connection Options	16
Low Sound Solutions	17
LSWE Discharge & Intake Attenuation	18
LRWB Discharge & Intake Attenuation	19
Freeze Protection Options	20-21
Heat Loss & Discharge Hood Dimensions	22
Steel Support	23
Specific Design Features	24
General Information	25
Engineering Data	26-42

LSWE and LRWB Principle of Operation

Low Sound and Low Rise Forced Draft Closed Circuit Coolers

EVAPCO's LSWE/LRWB Closed Circuit Coolers utilize Evapco's Thermal-Pak® coil design now featuring the revolutionary **CROSSCOOL** Internal Tube Enhancement. The **CROSSCOOL** Internal Tube Enhancement increases the internal heat transfer coefficient of the coil and thus increases the cooling capacity of the unit. This new and improved series of coolers is the ideal solution for indoor application, confined layouts, low sound requirements and direct replacements to name a few. Both models are designed for easy maintenance and long, trouble free operation.



LSWE

The standard for forced draft centrifugal fan designs,
Now more efficient than ever.

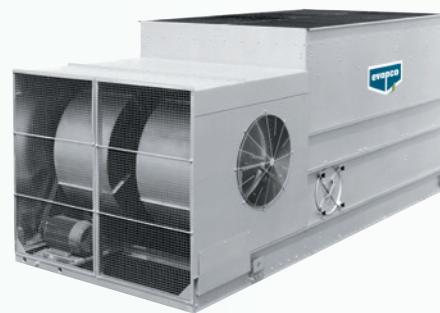

LRWB

With the fan section located beside the heat transfer casing, this unit satisfies even the strictest of height requirements in a unitary, compact design.

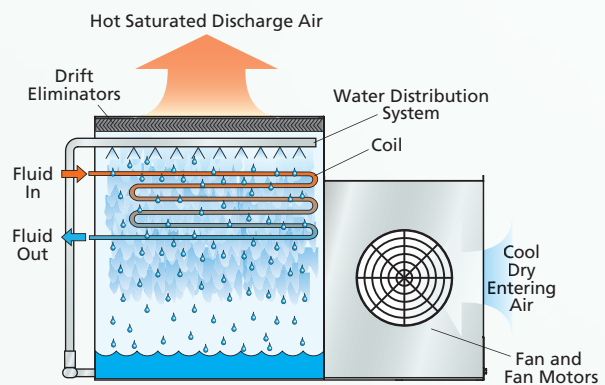
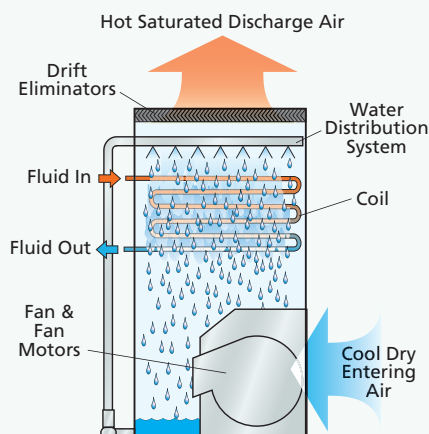

Principle of Operation

The process fluid is circulated through the coil of the closed circuit cooler. Heat from the process fluid is dissipated through the coil tubes to the water cascading downward over the tubes. Simultaneously air is blown through the unit by the fans and travels upward over the coil opposite the water flow. A small portion of the water is evaporated which removes the heat. The warm moist air is forced to the top of the closed circuit cooler by the fan and is discharged to the atmosphere. The remaining water falls to the sump at the bottom of the cooler where it is recirculated by the pump up through the water distribution system and back down over the coils.

Application Versatility

Centrifugal units are recommended for a wide range of installations. They are quiet, can easily be hidden, and are an excellent solution for installations where sound is sensitive, and when the unit must handle external static pressure.

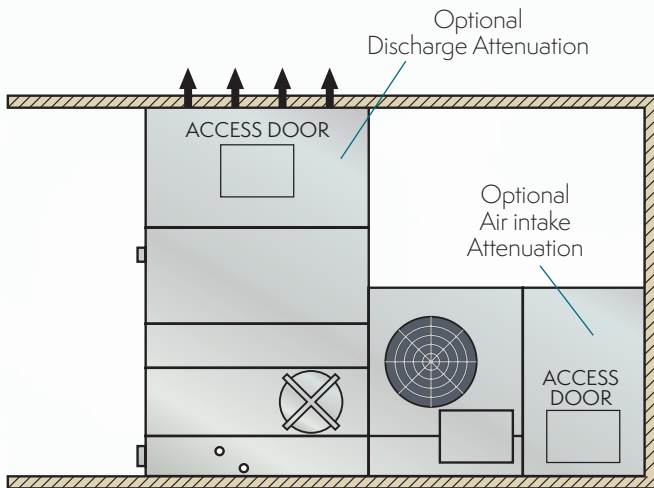

LRWB

Note: LRWB Shown Ducted on Both Inlet and Discharge

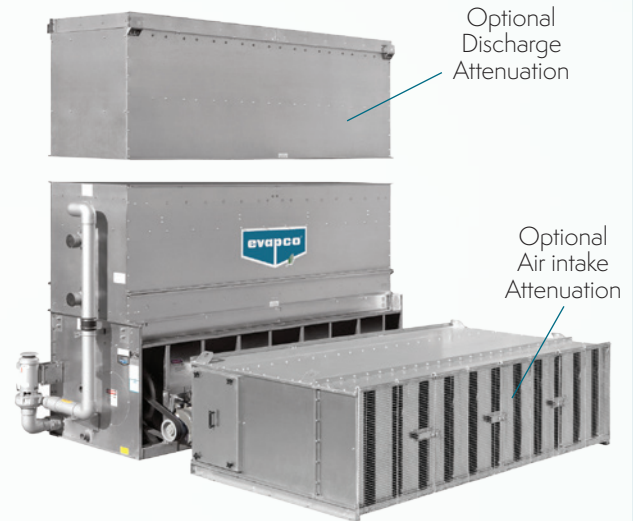

LSWE

Very Quiet Operation

Centrifugal fan units operate at low sound levels which make this design preferred for installations with external static pressure where noise is a concern. Additionally, since the sound from the fans is directional, single sided air entry models can be turned away from critical areas avoiding a sound problem. When even quieter operation is necessary, centrifugal fan models can be equipped with optional sound attenuation packages. See the Sound Reducing Options section of this catalog or consult the factory for details.

In addition, the LRWB features a specially engineered fan enclosure and drive system that is designed to offer very quiet operation without the high cost of external attenuation packages. The LRWB fan system was developed through hundreds of hours of laboratory tests resulting in the lowest standardized sound levels available in the industry. In fact, the sound level of the LRWB on average is 2 dBA quieter than competitors' similar models.

Indoor Installation

All LSWE and LRWB closed circuit coolers can be installed indoors where they normally require ductwork to and from the unit. The design of the ductwork should be symmetrical to provide even air distribution across both intake and discharge openings. Guidelines for ducted applications:

- 1) The static pressure loss imposed by the ductwork must not exceed 125 Pa. The cooler performance will be recalculated for the increased ESP.
- 2) For ducted installations, the solid bottom panel option must be ordered. On the LRWB, blank off plates will also be provided in lieu of the side air inlet screens with this option.
- 3) **NOTE:** Access doors must be located in the ductwork (by others) for service to the fan drive components and water distribution system.

Drawings are available showing recommended ductwork connections. See EVAPCO's layout guidelines for additional information.

LSWE Design & Construction Features

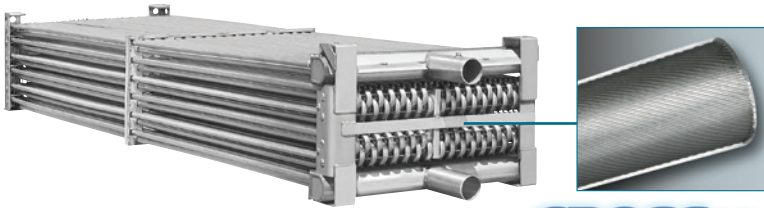

CROSSCOOL™
INTERNAL TUBE ENHANCEMENT

Galvanized Steel Coil Elliptical Thermal-Pak® COIL Construction Featuring **CROSSCOOL™** Internal Tube Enhancement Technology

- Internal tube enhancement increases fluid turbulence providing **additional evaporative capacity**
- Elliptical return bends allows for more circuits per coil bundle increasing maximum capacity per footprint
- Coil located in the airstream increasing dry bulb switchover temperature



Optional Factory Mounted Water Treatment Systems

The LSWE is available with multiple water treatment options, including a **Pulse~Pure®** (shown) non-chemical or a **Smart Shield®** (not shown) solid chemical water treatment system. EVAPCO offers a number of environmentally sensitive alternatives for treating water in evaporative cooled equipment. Each system includes all components required for an effective water treatment system; factory mounted and wired. Refer to pages 11-12 for more information.



The EVAPCO Performance Guarantee

Every LSWE product is rigorously thermal performance tested by EVAPCO and then independently certified by the Eurovent Association and the Cooling Technology Institute (CTI), so you know you're getting a solution that's guaranteed to get the job done.

*Mark owned by the Cooling Technology Institute

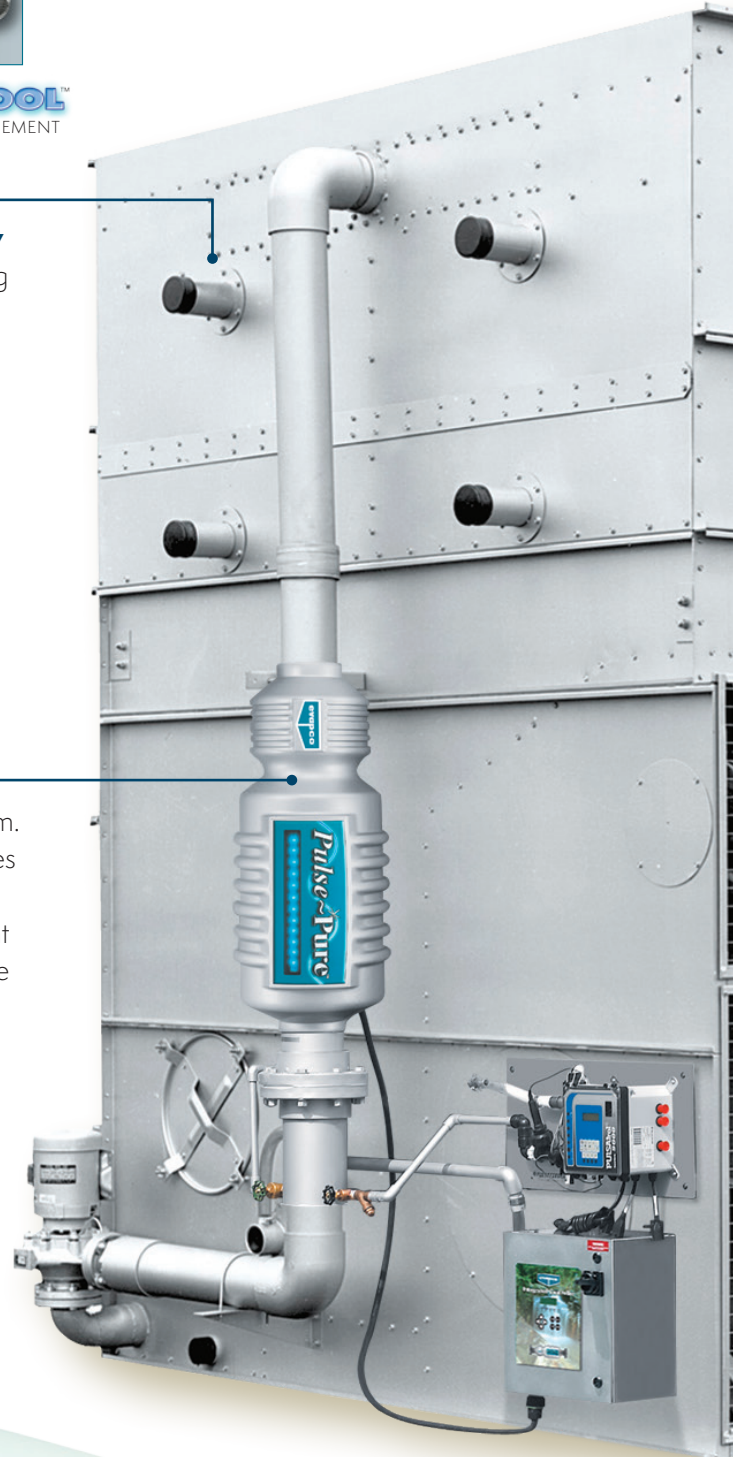

Zero Maintenance PVC Spray Distribution Header with ZM®II Nozzles

- Fixed position nozzles require zero maintenance
- Large orifice nozzles prevent clogging



Easy Field Assembly

- Ensures easy assembly and fewer fasteners
- Incorporates self-guiding channels to guide the coil casing section into position improving the quality of the field seam

Clean Pan Design

- Sloped design allows water to drain completely from cold water basin
- Easier removal of dirt and debris

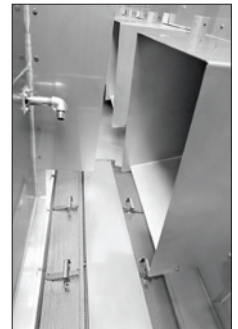

Totally Enclosed Fan Motors

- Assures long life
- All normal maintenance can be performed quickly from outside the unit
- If required, motor may be easily removed
- Motors are now located outboard on multi-motor units for even easier drive system access
- Premium efficient inverter-ready motors are standard

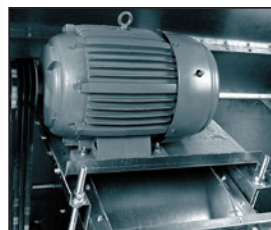

LRWB Design and Construction Features

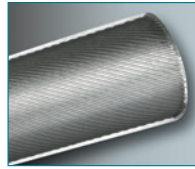
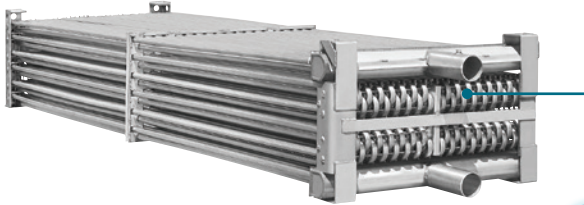

CROSSCOOL™
INTERNAL TUBE ENHANCEMENT

Galvanized Steel Coil

Elliptical Thermal-Pak® COIL Construction Featuring **CROSSCOOL™** Internal Tube Enhancement Technology

- Internal tube enhancement increases fluid turbulence providing **additional evaporative capacity**
- Elliptical return bends allows for more circuits per coil bundle increasing maximum capacity per footprint
- Coil located in the airstream increasing dry bulb switchover temperature

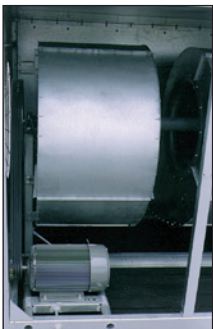

Easy to Service Motor & Drive System

- Belt tensioning and bearing lubrication can be performed from outside the unit
- Locking mechanism can also be used as a wrench to adjust the belts
- Motor is fully accessible by removing one inlet screen
- Split fan housings allow removal of all mechanical equipment through the end of the unit

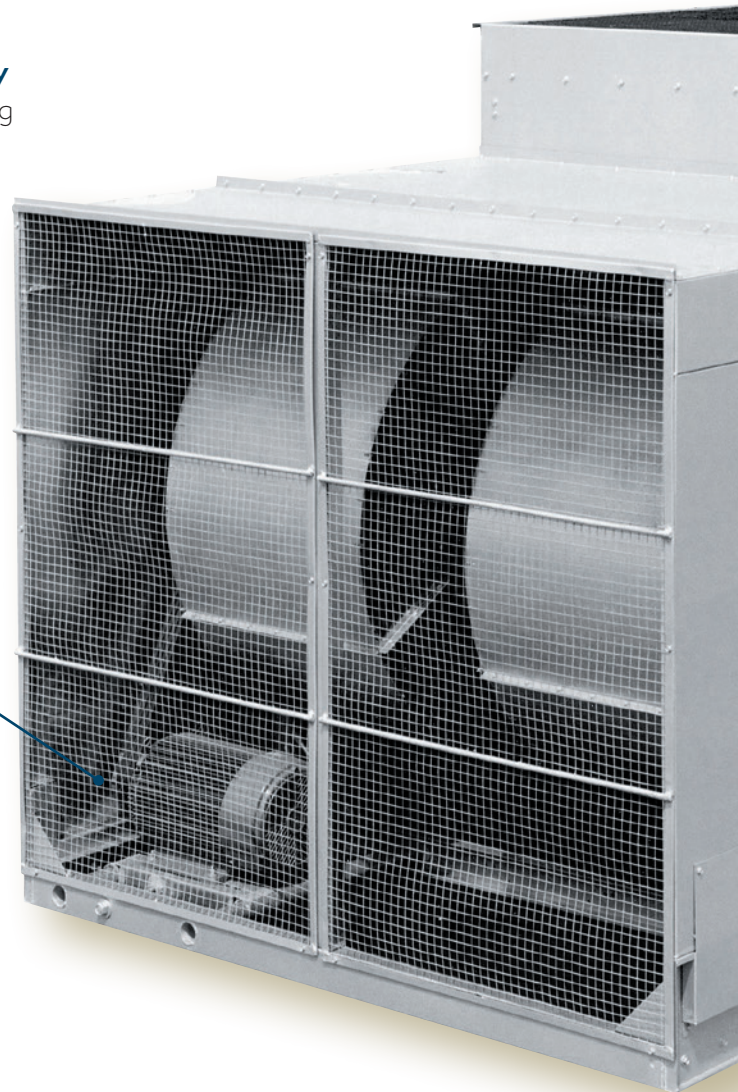

Zero Maintenance PVC Spray Distribution Header with ZM®II Nozzles

- Fixed position nozzles require zero maintenance
- Large orifice nozzles prevent clogging



Optional Factory Mounted Water Treatment Systems

The LRWB is available with multiple water treatment options, including a **Pulse~Pure**® (not shown) non-chemical or a **Smart Shield**® (not shown) solid chemical water treatment system. EVAPCO offers a number of environmentally sensitive alternatives for treating water in evaporative cooled equipment. Each system includes all components required for an effective water treatment system; factory mounted and wired. Refer to pages 11-12 for more information.



The EVAPCO Performance Guarantee

Every LRWB product is rigorously thermal performance tested by EVAPCO and then independently certified by the Eurovent Association and the Cooling Technology Institute (CTI), so you know you're getting a solution that's guaranteed to get the job done.

*Mark owned by the Cooling Technology Institute

Innovative Design Features

Elliptical Thermal-Pak® Heat Transfer Coil

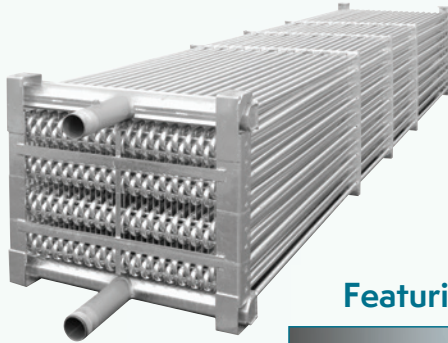

Featuring



THERMAL-PAK® ELLIPTICAL TUBE

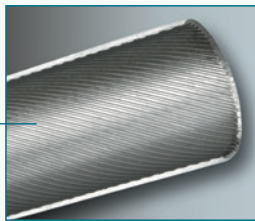

CROSSCOOL™
INTERNAL TUBE ENHANCEMENT

Galvanized steel elliptical Thermal-Pak® coil featuring **CROSSCOOL™** Internal Tube Enhancement Technology

- Internal Tube Enhancement provides additional evaporative capacity
- Elliptical tube design allows for more circuits per coil bundle increasing maximum capacity per footprint
- Elliptical tube design results in lower airflow resistance than typical round tube designs

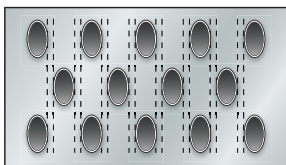

EVAPCO's Thermal-Pak®
Elliptical Tube

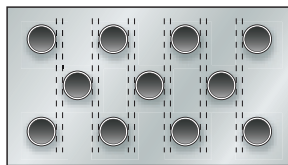

Competitors
Round Tube Coil

The LSWE and LRWB closed circuit coolers utilize EVAPCO's Thermal-Pak® coil design. The elliptical tube design allows for closer tube spacing, resulting in greater surface area per plan area than round-tube coil designs.

In addition, the Thermal-Pak® design has lower resistance to airflow and also permits greater water loading making the Thermal-Pak® coil the most efficient design available.

The Thermal-Pak® coil design also features EVAPCO's Internal Tube Enhancement Technology. This increases fluid turbulence through the coil, further increasing the evaporative capacity.

The coils are manufactured from high quality steel tubing following the most stringent quality control procedures. Each circuit is inspected to ensure the material quality and then tested before being assembled into a coil. Finally, the assembled coil is pneumatically tested at 15 barg under water to ensure it is leak free.

To protect the coil against corrosion, it is placed in a heavy steel frame and then the entire assembly is dipped in molten zinc (hot-dip galvanized) at a temperature of approximately 427°C.

NOTE: Closed circuit coolers should only be used on sealed, pressurized systems. Continual aeration of the water in an open system can cause corrosion inside the tubes of the coil leading to premature failure.

Stainless Steel Coil Option

Evapco offers the optional TITAN COIL. Constructed with type 304L Stainless Steel, the TITAN COIL is manufactured using EVAPCO's elliptical tube Thermal-Pak®.

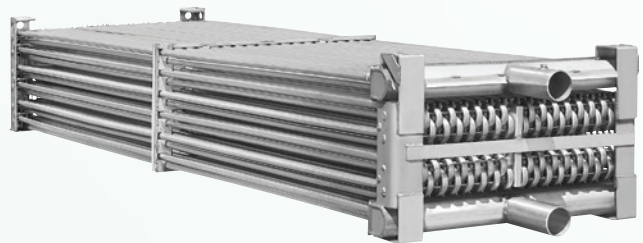

Thermal-Pak® Coil

Innovative Design Features

Fan Motor Mount

TEFC fan motors are mounted in a convenient open area for ease of belt tensioning, motor lubrication and electrical connection. The motor base is designed for easy adjustment and is locked into position to maintain proper belt tension.

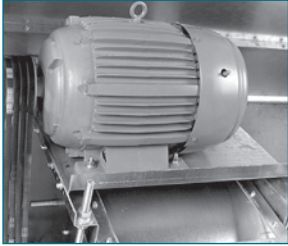

Example LSWE Fan Motor Mount

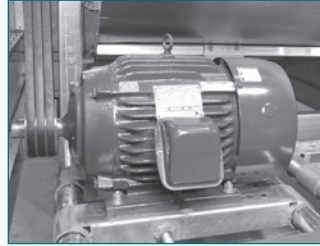

LRWB Fan Motor Mount

Fan Access-Split Housing

Another unique feature of the LRWB closed circuit cooler is the split fan housing. The split fan housing on the LRWB allows quick removal of the fans from the front end of the unit. This feature allows fan removal when units are placed side by side where space is minimal.



Mechanical Drive System Access

The LSWE and LRWB mechanical drive systems are easy to maintain. Bearing lubrication and belt adjustment can be performed from outside the unit. There is no need to remove fan screens to maintain important drive components. In addition, the locking mechanism used to maintain belt tension can also work as a wrench to adjust the belt.

Centrifugal Fan Assembly

Fans on LSWE and LRWB closed circuit coolers are of the forward curved centrifugal design with hot-dip galvanized steel construction. All fans are statically and dynamically balanced and are mounted in a hot-dip galvanized steel housing.



Maintenance Free ZM®II Spray Nozzle Water Distribution System

EVAPCO'S Zero Maintenance ZM®II spray nozzle remains clog-free while providing even and constant water distribution for reliable, scale-free evaporative cooling under all operating conditions.



ZM®II Nozzle

The heavy duty nylon ZM®II spray nozzles have a 33 mm diameter opening and a 38 mm splash plate clearance. Furthermore, the fixed position ZM®II nozzles are mounted in corrosion-free PVC water distribution pipes that have threaded end caps. Together, these elements combine to provide unequalled coil coverage and scale prevention, and make the industry's best performing non-corrosive, maintenance-free water distribution system.

High-Efficiency Drift Eliminators

EVAPCO's extremely efficient drift eliminator system removes entrained water droplets from the air stream, limiting the drift rate to less than 0.001% of the recirculating water rate in most instances.



This saves valuable water and enables you to place your cooling tower in areas where minimum water carryover is critical, such as parking lots.

The drift eliminators are constructed of inert PVC, which effectively eliminates corrosion of these vital components. They are assembled in sections to facilitate easy removal for inspection of the water distribution system.

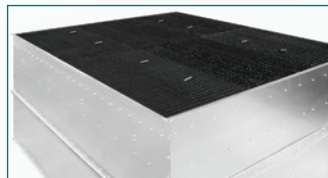

LSWE and LRWB Drift Eliminator



Drift Eliminators Removed for Coil Inspection

Water Treatment Solutions



Engineered to Improve Water Efficiency

The EVAPCO Water Saver™ utilizes capacitive deionization technology to reduce dissolved ion concentration, thus lowering the makeup water conductivity prior to use in an evaporative cooling system. Makeup water entering the Water Saver passes through individual cylinders which contain oppositely charged supercapacitors. Dissolved ions (except silica) are removed from the water as they are absorbed onto the charged capacitors. A typical 50% ion reduction allows the operating cycles of concentration to be safely doubled without an increase in scale or corrosion potential.

View the Water Saver video and Mechanical Specifications at evapco.eu to learn more.



Pretreatment System for Evaporative Cooling Equipment

Water Treatment Solutions



Pulse~Pure® Non-Chemical Water Treatment System

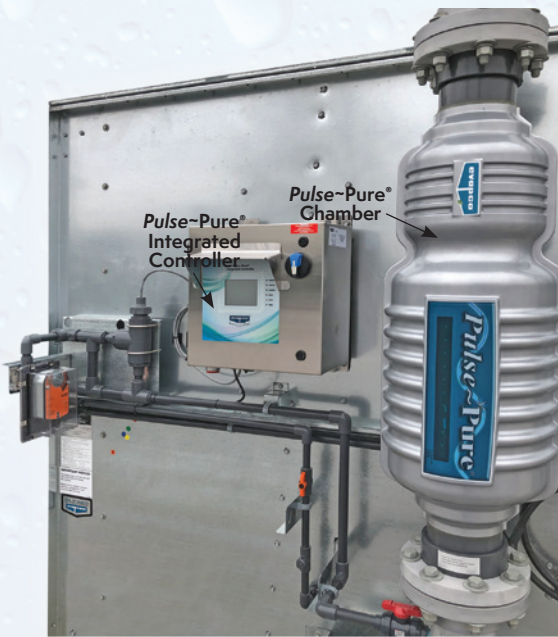

EVAPCO's **Pulse~Pure**® water treatment system utilizes pulsed electric field technology to provide an environmentally responsible alternative for the treatment of water in evaporative cooling equipment. The **Pulse~Pure**® system delivers short low- and high-frequency bursts of electromagnetic fields to the recirculating water in the fluid cooler.

- EVAPCO guarantees that total bacterial counts will not exceed 10,000 CFU/ml in the cooling water
- Controls scale, corrosion, and microbiological growth with absolutely no chemicals required
- Compact design with no moving parts and low energy consumption



Learn more about **Pulse~Pure**® at evapco.eu.



Smart Shield® Solid Chemical Water Treatment System

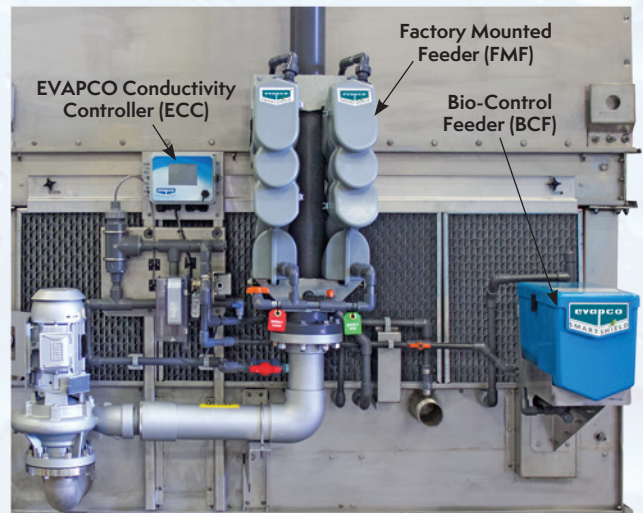

EVAPCO's **Smart Shield**® system utilizes proven solid chemistry delivered via our revolutionary feed system. With patented Controlled Release tablets, a scale and corrosion inhibitor is fed whenever your spray water pump is energized, keeping your system protected anytime the spray water pump is operating. **Smart Shield**® is a complete water treatment package that:

- Utilizes 'Bag in Bag' no touch chemical replenishments, making reloads easier and safer
- Creates reduced packaging, shipping and handling providing a reduced carbon footprint compared to liquid chemicals
- Eliminates the hazards associated with liquid chemicals, potential for liquid spills and the need for expensive feed pumps making it the easiest and safest chemical water treatment system available today



Watch a short product video at evapco.eu.

Stainless Steel Material Options

All LSWE and LRWB Series units are constructed with galvanized steel panels as standard. The following pages illustrate the available stainless steel construction material options for this series. Stainless steel options are available in both 304 and 316L stainless steel. Selection of these options only changes the sheet steel; optional accessories such as attenuation, discharge hoods, platforms, etc. are available in stainless steel only by special order. Stainless steel discharge hoods/attenuation have galvanized dampers with a stainless steel linkage. Accessories, coils, and fan shafts **do not** change to stainless steel with these options and are upgraded separately. The strainer in the basin is always 304 stainless steel independent of basin construction.

LSWE

Stainless Steel Basin up to Overflow Level Option

Includes Type 304 stainless steel basin panels up to the overflow level. All panels above the overflow, including the fan discharge cowls are Z-725 galvanized steel. Centrifugal fan wheels are **not available** in stainless steel.

This is the first stage of stainless steel on the LS Series units 2.4 m wide and larger. The "stainless steel basin up to overflow" option is not available on 1.2 and 1.5 m wide units.



Stainless Steel Water Touch Basin

All panels in the pan section in contact with the cooling water including the fan discharge cowls are constructed of Type 304 stainless steel. Remainder of unit constructed of Z-725 galvanized steel. All models with this option are furnished with epoxy coated fan wheels and shafts coated with a rust inhibitor. Centrifugal fan wheels are **not available** in stainless steel.



Stainless Steel Water Touch Unit

All panels in contact with the cooling water including the upper casing panels are constructed of Type 304 stainless steel. All models with this option are furnished with epoxy coated fan wheels and shafts coated with a rust inhibitor. Centrifugal fan wheels are **not available** in stainless steel.

This option designates the entire water section as stainless. Note that the fan housings and supports are still galvanized in this option.



All Stainless Steel Except Fans Option

All panels including the fan housings and supports are constructed of Type 304 stainless steel. All models with this option are furnished with epoxy coated fan wheels and shafts coated with a rust inhibitor. Centrifugal fan wheels are **not available** in stainless steel. With this option, all sheet metal is stainless including the fan housings and supports.



Stainless Steel Material Options

LRWB

Stainless Steel Cold Water Basin

With this option, the lowest section of the unit, as highlighted in the photograph to the right, is constructed of Type 304 stainless steel. On all LRWB units, the fan side inlet screens are PVC coated. Fan screens are galvanized.

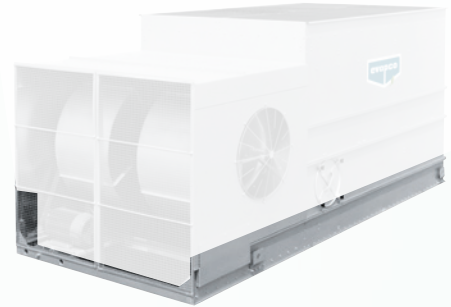

Stainless Steel Water Touch Basin

All panels in the pan section in contact with the cooling water including the fan discharge cowls are constructed of Type 304 stainless steel. The remainder of unit is constructed of Z-725 galvanized steel.

All models with this option are furnished with epoxy coated fan wheels and shafts coated with a rust inhibitor. Centrifugal fan wheels are **not available** in stainless steel. Fan screens are galvanized.

NOTE: LRWB models have carbon steel coils, which are hot dip galvanized after fabrication as standard.

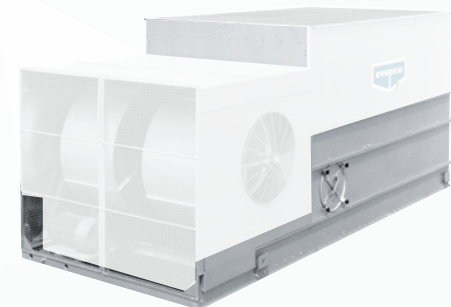

Stainless Steel Water Touch Unit

All panels in contact with the cooling water including the upper casing panels are constructed of Type 304 stainless steel. All models with this option are furnished with epoxy coated fan wheels and shafts coated with a rust inhibitor. Centrifugal fan wheels are **not available** in stainless steel. Fan screens are galvanized. This option designates the entire water section as stainless.



All Stainless Steel Option (Excluding Fans/Coils)

All panels including the fan housings and supports are constructed of Type 304 stainless steel. All models with this option are furnished with epoxy coated fan wheels and shafts coated with a rust inhibitor. Centrifugal fan wheels are **not available** in stainless steel. With this option, all sheet metal is stainless including the Fan Housings and Supports. Fan screens are stainless steel.

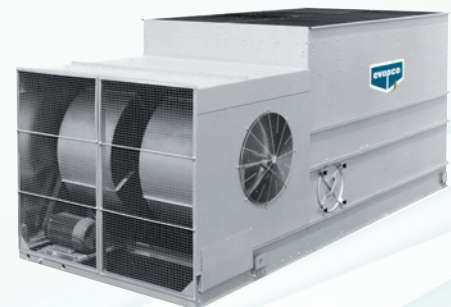

Coil Connection Options

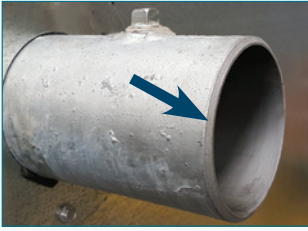

Beveled For Weld (BFW) Coil Connections

EVAPCO closed circuit coolers are provided with beveled for weld (BFW) coil connections as standard. Beveled edges simplify field welding and allow welds to fully penetrate.



Optional Factory Mounted Crossover Piping

Some EVAPCO closed circuit coolers are design for "series flow" coil operation where the coils inside of one cell are operated in series. These units are denoted by a "-Z" following the unit model number. These units require "crossover piping" from one coil to the other. As an option, this piping can be installed in the factory for simplified field installation.

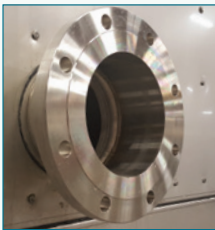

Optional Flanged Coil Connections

EN1092-1 flanged connections can be provided as an optional coil connection. The flanged coil connection allows for faster and easier field piping to a mating flanged connection. Matching counter-flanges can flanges can be provided as an option.

Please contact your local EVAPCO sales representative for more information.

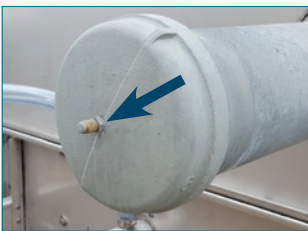

Optional Nitrogen Charged Coils

For projects requiring long term storage or ocean freight, coils can be nitrogen charged at the factory to prevent corrosion inside of the coil circuits.

NOTE: All coil connections are constructed from the same material as the coil.

Low Sound Solutions

Sound Attenuation Packages

The centrifugal fan design of the LSWE and LRWB models operate at lower sound levels which make these units preferable for installations where noise is a concern. For sound-sensitive applications, the LSWE and LRWB centrifugal fan models may be supplied with various stages of intake and/or discharge attenuation packages which further reduce sound levels.

Consult the factory for certified sound data for each sound attenuation option.

NOTE: Sound attenuation packages may require oversized fan motors.

Fan Side Inlet Attenuation (LRWB Only)

Reduces sound radiated from the fan side air intakes and has an open side to allow for air entry. **This attenuation package ships loose to be mounted in the field on each side of the closed circuit cooler over the fan intakes.**

Fan End Inlet Attenuation

Reduces sound radiated through the end air intakes. It consists of baffled panels that change the path of the air entry and capture the radiated noise thus reducing the overall sound levels generated. In addition, the external belt adjustment mechanism is extended through the inlet attenuator to allow for easy adjustment without having to enter the unit. Solid bottom panels are included with this option to force the inlet air through the attenuator.

Discharge Attenuation

The discharge attenuation hood features a straight-sided design with insulated baffles to reduce the overall sound levels of the discharge air. The discharge attenuation incorporates a large access panel to allow entry to the drift eliminators and water distribution system. **If a higher discharge velocity is required with minimal sound attenuation, a tapered discharge hood is available.**

**Straight Sided
Discharge Attenuation**
(LSWE and LRWB)

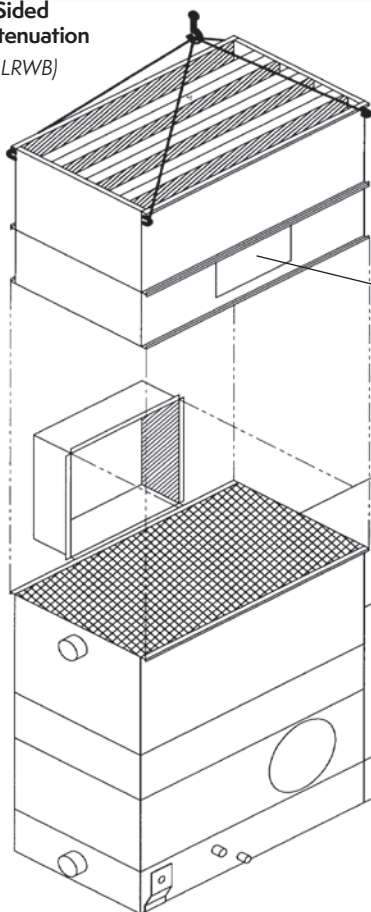

Drift Eliminator and
Water Distribution
Access Panel

Motor and Drive
Access Panel

**Fan End Inlet
Attenuation**
(LSWE and LRWB)

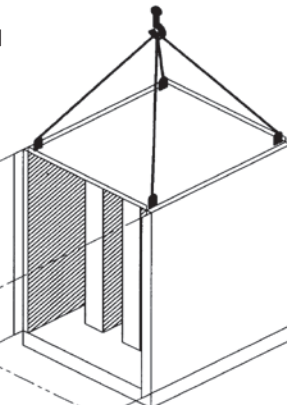

**Fan Side Inlet
Attenuation**
(LRWB Only)

Example of LRWB model

LSWE Discharge & Intake Attenuation

LSWE Discharge Attenuation Dimensions**

Box size	H1 (mm)	L1 (mm)	W1 (mm)	Weight (kg)*	N° of Attenuators
4x6	1190	1830	1160	255	1
4x9	1190	2720	1160	345	1
4x12	1190	3640	1160	465	1
4x18	1190	5490	1160	645	1
5x12	1190	3640	1570	570	1
5x18	1190	5490	1570	800	1
8x12	1810	3640	2420	800	1
8x18	1810	5490	2420	1110	1
8x24	1810	3670	2420	800	2
8x36	1810	5505	2420	1110	2
10x12	1810	3640	3020	960	1
10x18	1810	5490	3030	1335	1
10x24	1810	3670	3020	960	2
10x36	1810	5510	3030	1335	2

LSWE Intake Attenuation Dimensions**

Box size	H2 (mm)	L2 (mm)	Compact (kg)	Basic (kg)	Extended (kg)	N° of Attenuators
4x6	1010	1830	275	345	445	1
4x9	1010	2720	395	485	610	1
4x12	1010	3640	510	615	775	1
4x18	1010	5490	795	935	1145	1
5x12	1170	3640	625	710	840	1
5x18	1170	5480	965	1075	1235	1
8x12	2070	3650	825	965	1175	1
8x18	2070	5490	1255	1440	1715	1
8x24	2070	3670	825	960	1160	2
8x36	2070	5560	1270	1440	1696	2
10x12	2260	3650	915	1055	1260	1
10x18	2260	5490	1245	1485	1835	1
10x24	2260	3670	920	1050	1245	2
10x36	2260	5560	1425	1585	1820	2

* Attenuation dimensions may vary slightly from catalog. See factory certified prints for exact dimensions.

NOTE: Weights provided in the tables above are per attenuator.

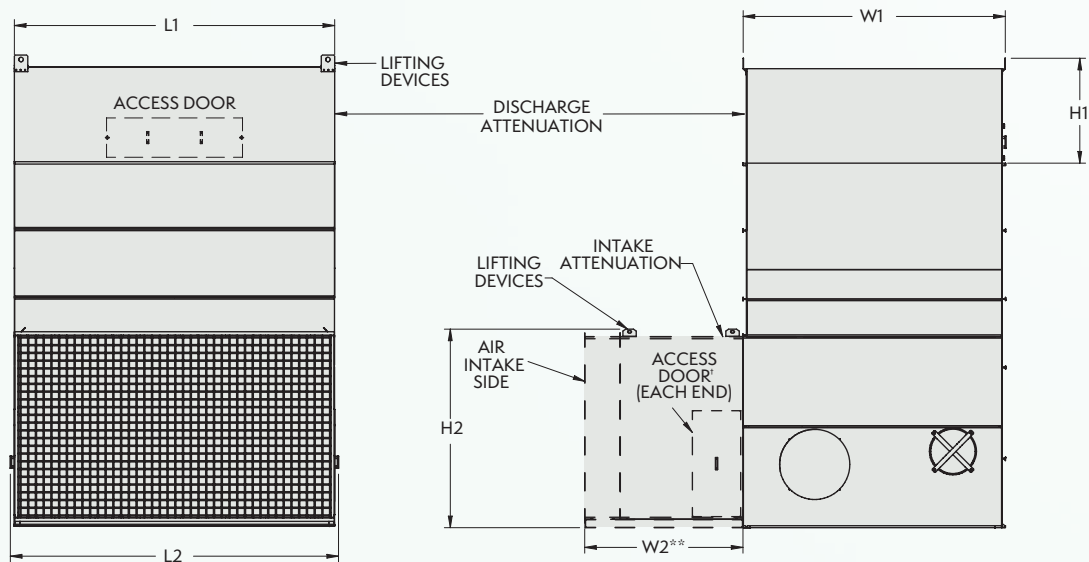

LSWE Attenuation

** Measurements for W2 will vary based on selected attenuation (Compact, Basic, or Extended).

† Please note the Compact option has NO access door.

W2 Variations (mm)	
Compact	1142
Basic	1410
Extended	1810

NOTE: Intake sound attenuation must be fully supported. If the recommended steel support is being used a third I-beam is required for the intake attenuation. Refer to page 22.

NOTE: Sound attenuation packages may require oversized fan motors.

LRWB Discharge & Intake Attenuation

LRWB Discharge Attenuation Dimensions*

Coil Casing Footprint	H1 (mm)	L1 (mm)	W1 (mm)	Weight per Attenuator (kg)	Nr. of Attenuators
3' x 6'	1153	1822	1029	304	1
5' x 6'	1153	1810	1540	386	1
5' x 9'	1153	2724	1540	530	1
5' x 12'	1153	3648	1540	903	1
8' x 9'	1153	2724	2388	712	1
8' x 12'	1153	3648	2388	921	1

LRWB Fan End Attenuation Dimensions*

Coil Casing Footprint	H2 (mm)	L2 (mm)	W2 (mm)	Weight per Attenuator (kg)	Nr. of Attenuators
3' x 6'	1622	1108	1029	367	1
5' x 6'	2022	1105	1540	581	1
5' x 9'	2022	1105	1540	581	1
5' x 12'	2022	1105	1540	581	1
8' x 9'	2022	1108	2394	694	1
8' x 12'	2022	1108	2394	694	1

LRWB Fan Side Attenuation Dimensions*

Coil Casing Footprint	H3 (mm)	L3 (mm)	W3 (mm)	Weight per Attenuator (kg)	Nr. of Attenuators
3' x 6'	854	883	1645	31	2
5' x 6'	937	1372	2156	47	2
5' x 9'	937	1372	2156	47	2
5' x 12'	937	1372	2156	47	2
8' x 9'	1076	1121	3010	47	2
8' x 12'	1076	1121	3010	47	2

* Attenuation dimensions may vary slightly from catalog. See factory certified prints for exact dimensions.

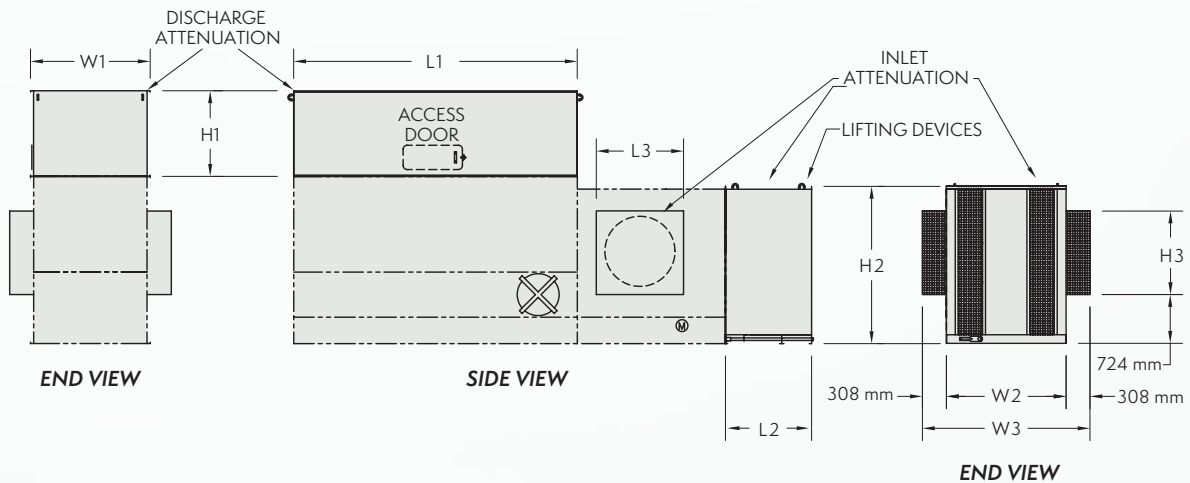

LRWB Attenuation

NOTE: Intake sound attenuation must be fully supported. If the recommended steel support is being used, extended "I" beams are required for the intake attenuation. Refer to page 22.

NOTE: Sound attenuation packages may require oversized fan motors.

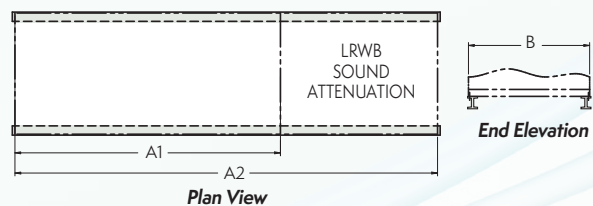

Freeze Protection and Heat Loss

Freeze Protection

If the units are installed in a cold climate and operated year-round, freeze protection must be provided for the heat exchanger coil in the unit as well as for the recirculating water system.

Recirculating Water System Freeze Protection Options

Remote Sump Configuration

The surest way to protect the recirculating water system from freezing is with a remote sump. The remote sump should be located inside the building and below the unit. **When a remote sump arrangement is selected, the spray pump is provided by others and installed at the remote sump.** All water in the closed circuit cooler basin should drain to the remote sump when the spray pump cycles off.

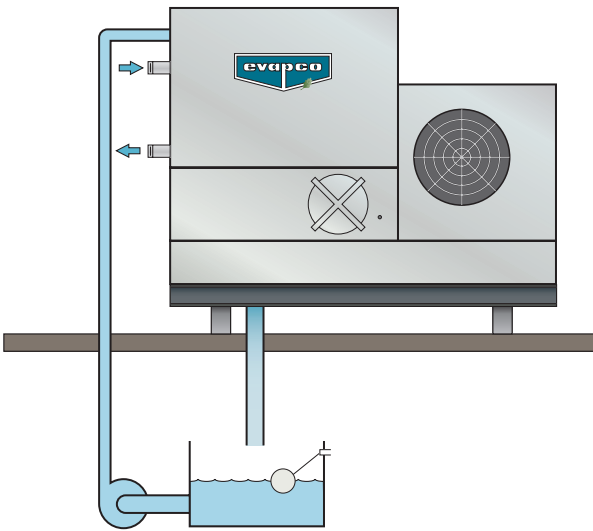

Basin Heater Package

If a remote sump configuration is not practical, electric basin heater packages are available to keep the pan water from freezing when the unit cycles off. Water lines to and from the unit, spray pump and related piping should be heat traced and insulated up to the overflow level to protect from freezing. **Basin heaters should be interlocked with the water circulating pump to prevent their operation when the pump is energized.**

This unit should not be operated dry (fans on, pump off) unless the basin is completely drained or the heaters have been oversized and the unit has been designed for dry operation. Consult the factory when dry operation is a requirement.

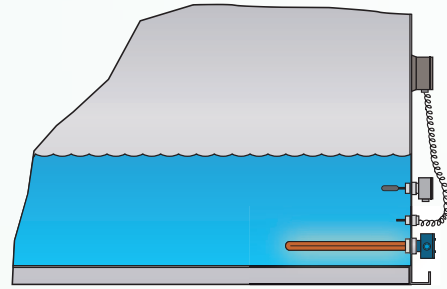

LSWE Basin Heater Sizing

Unit Footprint	kW (-18°C)	kW (-28°C)	kW (-40°C)
4' x 6'	(1) 2	(1) 3	(1) 4
4' x 9'	(1) 3	(1) 4	(1) 5
4' x 12'	(1) 3	(1) 5	(1) 7
4' x 18'	(1) 5	(1) 7	(1) 9
5' x 12'	(1) 4	(1) 6	(1) 8
5' x 18'	(2) 3	(2) 4	(1) 12
8' x 12'	(1) 5	(1) 7	(1) 9
8' x 18'	(2) 4	(2) 5	(1) 15
8P' x 12'	(1) 5	(1) 8	(1) 10
8P' x 18'	(2) 4	(2) 6	(2) 7
8P' x 24'	(2) 5	(2) 7	(2) 10
8P' x 36'	(2) 7	(2) 12	(2) 15
10' x 12'	(1) 7	(1) 10	(1) 15
10' x 18'	(2) 5	(2) 7	(2) 10
10' x 24'	(2) 7	(2) 10	(2) 15
10' x 36'	(2) 10	(4) 7	(4) 9

LRWB Basin Heater Sizing

Unit Footprint	kW (-18°C)	kW (-28°C)	kW (-40°C)
3' x 6'	(1) 2	(1) 3	(1) 4
5' x 6'	(1) 3	(1) 5	(1) 6
5' x 9'	(1) 4	(1) 6	(1) 8
5' x 12'	(1) 6	(1) 8	(1) 12
8' x 9'	(1) 7	(1) 9	(1) 12
8' x 12'	(1) 9	(1) 12	(1) 16

Freeze Protection and Heat Loss

Heat Exchanger Coil Freeze Protection Options

The simplest and most foolproof method of protecting the heat exchanger coil from freeze-up is to use a glycol solution. If this is not possible, an auxiliary heat load must be maintained on the coil at all times so that the water temperature does not drop below 10°C when the cooler is shut down and, a minimum recommended flow rate per unit as shown in the table below must be maintained. Refer to Heat Loss Data Table on page 22 for heat loss data.

LSWE Minimum Flows for Freeze Protection

Unit Footprint	Minimum Flow for Freeze Protection	
	Standard Unit (l/s)	Series Flow Unit (-Z) (l/s)
4' x 6'	4.16	2.08
4' x 9'	4.16	2.08
4' x 12'	4.16	2.08
4' x 18'	4.16	2.08
5' x 12'	5.93	2.97
5' x 18'	5.93	2.97
8P' x 12'	9.34	4.67
8P' x 18'	9.34	4.67
8P' x 24'	18.67	9.34
8P' x 36'	18.67	9.34
10' x 12'	11.86	5.93
10' x 18'	11.86	5.93
10' x 24'	23.72	11.86
10' x 36'	23.72	11.86

LRWB Minimum Flows for Freeze Protection

Coil Casing Footprint	Minimum Flow for Freeze Protection	
	Standard Unit (l/s)	Series Flow Unit (-Z) (l/s)
3' x 6'	3.79	1.89
5' x 6'	5.93	2.97
5' x 9'	5.93	2.97
5' x 12'	5.93	2.97
8' x 9'	9.34	4.67
8' x 12'	9.34	4.67

If an anti-freeze solution is not used, the coil must be drained immediately whenever the pump is shut down or flow stops. Care must be taken to ensure that the piping is sized to allow the water to flow quickly from the coil. This method of freeze control should only be used in an emergency situation. Coils should not be drained for an extended period of time. Leaving the coil drained and open to the atmosphere can cause corrosion inside the tubes which may lead to premature coil failure.

The amount of glycol required for a system will depend upon the total volume of water in the closed loop and the winter ambient conditions for the installation. The engineering data tables presented on pages 25-41 provide the water volume contained inside the cooler coils to assist in this calculation.

Discharge Hoods with Positive Closure Dampers

When a closed circuit cooler is used in a water-to-air heat pump system or in certain process cooling applications, a method of reducing the heat loss during idle periods of wintertime operation may be required. **For these cases, an optional discharge hood with positive closure dampers and damper actuator is available.**

The discharge hood with dampers is designed to minimize the heat loss from convective airflow through an idle cooler. Further reductions in heat loss may be obtained with the addition of insulation to the hood and casing, minimizing conductive heat losses. **Optional insulation may be factory-installed on the hood and casing or field-installed by an insulation contractor.**

The discharge hood and dampers are constructed of hot-dip galvanized steel as standard. Hoods are equipped with access panels to facilitate maintenance on the eliminators and water distribution system. The dampers, damper actuator and linkage are all factory-assembled. **Actuator controls and wiring are field-supplied by others. Damper actuators require 230 volt power supply. Stainless steel discharge hoods with galvanized positive closure dampers are available as an optional accessory.**

The system control sequence should provide for dampers to be fully open before the fans are running and closed when the fans are off; the damper actuator must be interlocked with the temperature control system for this purpose. **When a tapered discharge hood is specified, the cooler performance will be recalculated to account for the additional static pressure.**

Heat loss data is provided for standard units without hoods, with hoods and with hoods and insulation. Table ratings are based on 10°C water in the coil, -23°C ambient and 72 km/h winds (fan and pump off).

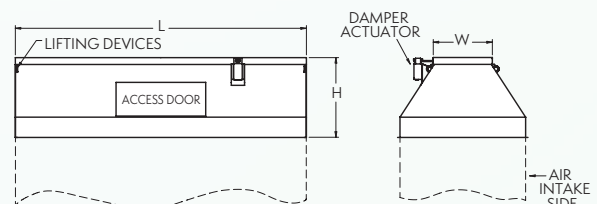

Tapered Discharge Hood (See page 22 for dimensions)

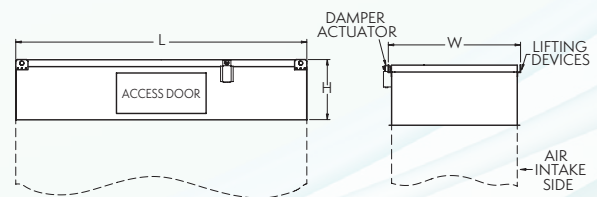

Straight-Sided Discharge Hood (See page 22 for dimensions)

Heat Loss & Discharge Hood Dimensions

LSWE Box Size	Standard Unit (kW)	Unit with Hood (kW)	With Hood & Insulation (kW)
4-2x6	11	9	6
4-3x6	15	10	7
4-4x6	18	11	7
4-5x6	20	12	8
4-3x9	23	13	9
4-4x9	27	15	10
4-5x9	31	16	10
4-3x12	31	16	11
4-4x12	37	18	12
4-5x12	42	20	13
5-3x12	44	21	14
5-4x12	53	23	15
5-5x12	59	25	16
5-6x12	63	27	17
5-7x12	68	29	19
4-3x18	46	23	15
4-4x18	56	25	16
4-5x18	62	27	17
5-3x18	66	29	19
5-4x18	79	31	20
5-5x18	89	34	22
5-6x18	95	37	24
5-7x18	103	40	26
8P-3x12	67	29	19
8P-4x12	81	31	20
8P-5x12	91	33	22
8P-6x12	97	35	23
10-3x12	87	32	21
10-4x12	105	35	22
10-5x12	118	37	24
10-6x12	125	40	26
10-7x12	136	43	28

LSWE Box Size	Standard Unit (kW)	Unit with Hood (kW)	With Hood & Insulation (kW)
8P-3x18	92	39	25
8P-4x18	111	42	27
8P-5x18	138	44	29
8P-6x18	147	47	30
8P-7x18	159	51	33
10-3x18	131	42	27
10-4x18	158	45	29
10-5x18	178	49	31
10-6x18	189	52	33
10-7x18	205	56	36
8P-3x24	134	58	37
8P-4x24	162	62	40
8P-5x24	182	66	43
8P-6x24	193	70	45
8P-7x24	209	76	49
10-3x24	173	64	41
10-4x24	209	69	44
10-5x24	235	74	47
10-6x24	250	79	51
10-7x24	271	85	55
8P-3x36	202	78	50
8P-4x36	245	83	53
8P-5x36	275	88	57
8P-6x36	293	94	60
8P-7x36	318	102	65
10-3x36	255	84	54
10-4x36	316	90	58
10-5x36	355	97	62
10-6x36	378	103	66
10-7x36	410	112	71

LRWB Box Size	Standard Unit (kW)	Unit with Hood (kW)	With Hood & Insulation (kW)
3-2x6	10	9	7
3-3x6	14	11	7
3-4x6	16	12	8
3-5x6	19	13	8
5-2x6	16	13	9
5-3x6	22	14	9
5-4x6	26	15	10
5-5x6	29	16	10
5-3x9	33	18	12
5-4x9	39	19	13
5-5x9	44	21	13
5-6x9	47	22	14
5-7x9	48	26	17
5-3x12	44	22	14
5-4x12	53	24	15
5-5x12	59	25	17
5-6x12	63	27	18
5-7x12	64	32	20
8-3x9	50	23	15
8-4x9	61	25	16
8-5x9	68	27	17
8-6x9	73	28	18
8-7x9	74	33	21
8-3x12	67	28	18
8-4x12	81	30	19
8-5x12	91	32	21
8-6x12	97	34	22
8-7x12	99	39	25

Discharge Hood Dimensions

LSWE Tapered Discharge Hood Dimensions

Unit Footprint	H (mm)	L (mm)	W (mm)	Weight per Hood (kg)	# of Hoods
4' x 6'	740	1830	510	75	1
4' x 9'	740	2720	510	95	1
4' x 12'	740	3640	510	125	1
4' x 18'	740	5490	510	170	1
5' x 12'	910	3640	710	165	1
5' x 18'	910	5490	710	215	1
8P' x 12'	990	3650	1130	215	1
8P' x 18'	990	5490	1130	270	1
8P' x 24'	990	3640	1130	215	2
8P' x 36'	990	5490	1130	270	2
10' x 12'	1190	3650	1450	275	1
10' x 18'	1190	5490	1450	355	1
10' x 24'	1190	3640	1450	275	2
10' x 36'	1190	5490	1450	355	2

LSWE Straight-Sided Discharge Hood Dimensions

Unit Footprint	H (mm)	L (mm)	W (mm)	Weight per Hood (kg)	# of Hoods
4' x 6'	740	1830	1160	75	1
4' x 9'	740	2720	1160	85	1
4' x 12'	740	3640	1160	120	1
4' x 18'	740	5490	1160	150	1
5' x 12'	740	3640	1570	125	1
5' x 18'	740	5490	1570	165	1
8P' x 12'	760	3650	2420	155	1
8P' x 18'	760	5490	2420	190	1
8P' x 24'	760	3640	2420	155	2
8P' x 36'	760	5490	2420	190	2
10' x 12'	660	3640	3020	170	1
10' x 18'	660	5492	3020	240	1
10' x 24'	660	3640	3020	170	2
10' x 36'	660	5492	3020	240	2

LRWB Tapered Discharge Hood Dimensions

Coil Casing Footprint	H (mm)	L (mm)	W (mm)	Weight per Hood (kg)	# of Hoods
3' x 6'	530	1830	485	60	1
5' x 6'	910	1830	740	100	1
5' x 9'	910	2720	740	120	1
5' x 12'	910	3650	740	155	1
8' x 9'	990	2720	1080	170	1
8' x 12'	990	3650	1080	205	1

LRWB Straight-Sided Discharge Hood Dimensions

Coil Casing Footprint	H (mm)	L (mm)	W (mm)	Weight per Hood (kg)	# of Hoods
3' x 6'	660	1830	1030	75	1
5' x 6'	660	1830	1540	85	1
5' x 9'	660	2720	1540	100	1
5' x 12'	660	3650	1540	120	1
8' x 9'	660	2720	2390	120	1
8' x 12'	660	3650	2390	140	1

Steel Support

Steel Support

The recommended support for EVAPCO Closed Circuit Coolers is structural I-beams located under the outer flanges and running the entire length of the unit. Mounting holes 19 mm in diameter are located in the bottom channels of the pan section to provide for bolting to the structural steel. (Refer to certified drawings from the factory for bolt hole locations.)

Beams should be level to within 1/360 of unit length, not to exceed 13 mm before setting the unit in place. Do not level the unit by shimming between it and the I-beams as this will not provide proper longitudinal support.

LRWB Dimensions

Coil Casing Footprint	A1 (Unit Only) (mm)	A2 (Unit with Intake Atten.) (mm)	B (mm)
3' x 6'	3096	4207	1029
5' x 6'	3731	4842	1540
5' x 9'	4629	5740	1540
5' x 12'	5553	6664	1540
8' x 9'	4629	5740	2388
8' x 12'	5553	6664	2388

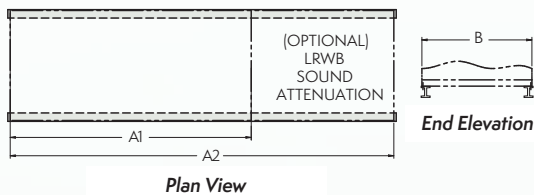

LSWE Dimensions

Coil Casing Footprint	B1 (Unit Only)	B2 (Compact Option)	B3 (Basic Option)	B4 (Extended Option)	A
4 x 6	1235	2378	2648	3048	1826
4 x 9	1235	2378	2648	3048	2724
4 x 12	1235	2378	2648	3048	3645
4 x 18	1235	2378	2648	3048	5486
5 x 12	1651	2794	3064	3453	3645
5 x 18	1651	2794	3064	3453	5483
8 x 12	2388	3531	3800	4188	3651
8 x 18	2388	3531	3800	4188	5486
8 x 24	2388	3531	3800	4188	7341
8 x 36	2388	3531	3800	4188	11011
10 x 12	2991	4134	4404	4791	3651
10 x 18	2991	4134	4404	4791	5493
10 x 24	2991	4134	4404	4791	7344
10 x 36	2991	4134	4404	4791	11027

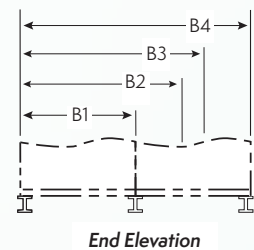
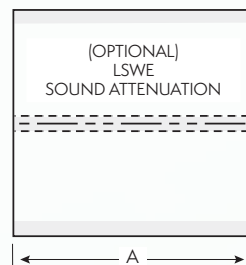

Optional Equipment

Electric Water Level Control

Closed Circuit Coolers may be ordered with an electric water level control in lieu of the standard mechanical float and make-up assembly. This package provides accurate control of water levels and does not require field adjustment.



Bottom Screens

Protective inlet screens are provided on the sides and/or end of the unit's air intake. Screens are not provided below the fan section since most units are mounted on the roof or at ground level. It is recommended that bottom screens be added to the unit when it will be elevated. These screens can be provided by the factory at an additional cost or added by the installing contractor.

Solid Bottom Panels for Ducted Installations

When centrifugal fan units are installed indoors and intake air is ducted to the unit, a solid bottom panel is required to completely enclose the fan section and prevent the unit from drawing air from the room into the fan intakes. When this option is ordered, air inlet screens are omitted and the next larger size fan motor must be used to overcome the additional static pressure.

Specific Design Features

LRWB Reduced Height and Maintenance Accessibility

The LRWB has been designed to satisfy installation requirements where height limits must be observed. The lower profile design of the LRWB does not, however, sacrifice maintenance accessibility for reduced height. Its unique casing design allows the water distribution system, cold water basin, fan section and other unit components to be easily maintained.

Small, light-weight sections of the drift eliminators can be easily removed to access the water distribution system. A large circular access door is located on the side of the cold water basin to allow adjustment of the float assembly, removal of the stainless steel strainers and cleaning of the basin. The fan motor and drive system are located at one end of the unit and are completely accessible by removing the inlet screens. Routine bearing lubrication and belt tensioning can be performed from the exterior of the unit without removing the inlet screens.

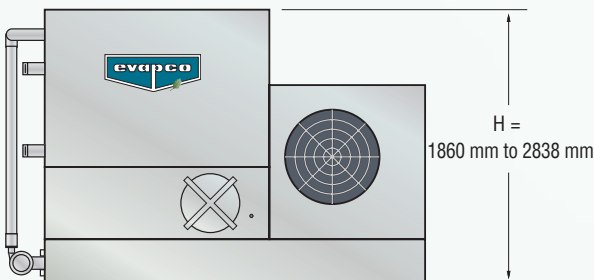

Low Installed Costs

The compact, unitary design of the LRWB closed circuit cooler allows it to be shipped completely assembled. This results in lower transportation costs and no assembly requirements at the job site.

NOTE: Options such as sound attenuation and discharge hoods will require additional lifts and some minor assembly.

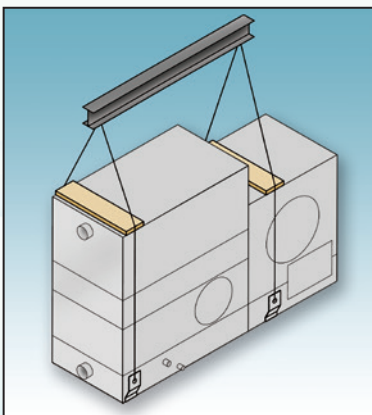

Transport of a Pre-Assembled Unit

Since the LRWB ships fully assembled, it is ideal for truck-mounted applications, for remote sites or temporary installations.

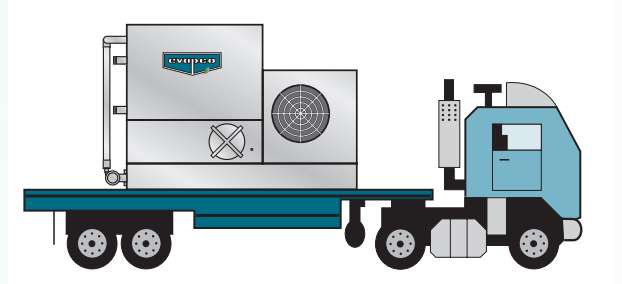

Stainless Steel Cold Water Basin

Stainless steel cold water basins are optional on the LRWB. Additional upgrades to stainless steel water touch basins, stainless steel water touch units and all stainless steel construction are also available on this unit. For more information on stainless steel construction options, refer back to pages 14 and 15 of this catalog.



Integral Fan Enclosure for Lower Sound

The LRWB comes standard with an integral fan enclosure that reduces sound levels by 2 dB. This 3-sided enclosure also protects the fan and drive system for longer equipment life.

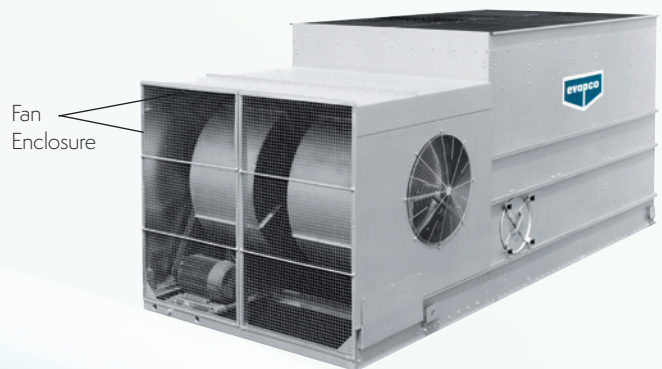

General Information

Design

EVAPCO closed circuit coolers are of heavy-duty construction and designed for long trouble-free operation. Proper equipment selection, installation and maintenance is, however, necessary to ensure full unit performance. Some of the major considerations in the application of a cooler are presented below. For additional information, contact the factory.

Air Circulation

It is important that proper air circulation be provided. The best location is on an unobstructed roof top or on ground level away from walls and other barriers. Those closed circuit coolers located in wells, enclosures or adjacent to high walls must be properly located to avoid the problems associated with recirculation.

Recirculation raises the wet bulb temperature of the entering air causing the water temperature to rise above the design. For these cases, the discharge of the unit should be located at a height even with the adjacent wall, thereby reducing the chance of recirculation. For additional information, see the EVAPCO equipment layout manual.

Good engineering practice dictates that the closed circuit cooler discharge air not be directed or located close to or in the vicinity of building air intakes.

Piping

Cooler piping should be designed and installed in accordance with generally accepted engineering practices. The piping layout should be symmetrical on multiple unit systems, and sized for a reasonably low water velocity and pressure drop. The standard closed circuit cooler is recommended only on a closed, pressurized system. The piping system should include an expansion tank to allow for fluid expansion and purging air from the system.

NOTE: *Closed circuit coolers should never be used on an open type system. An open type system with a cooler may result in premature coil failure.*

The piping system should be designed to permit complete drainage of the heat exchanger coil. This will require a vacuum breaker or air vent to be installed at the high point and a drain valve installed at the low point of the piping system. Both must be adequately sized.

All piping should be securely anchored by properly designed hangers and supports. No external loads should be placed upon the cooler connections, nor should any of the pipe supports be anchored to the cooler framework.

Recirculating Water Quality

Proper water treatment is an essential part of the maintenance required for evaporative cooling equipment. A well designed and consistently implemented water treatment program will help to ensure efficient system operation while maximizing the equipment's service life. **If EVAPCO factory mounted water systems are not utilized**, a qualified water treatment company should design a site specific water treatment protocol based on equipment (including all metallurgies in the cooling system), location, makeup water quality, and usage.

Bleed off

Evaporative cooling equipment requires a bleed or blowdown line, located on the discharge side of the recirculating pump, to remove concentrated (cycled up) water from the system. EVAPCO recommends an automated conductivity controller to maximize the water efficiency of your system. **If EVAPCO factory mounted water systems are not utilized**, based on recommendations from your water treatment company, the conductivity controller should open and close a motorized ball or solenoid valve to maintain the conductivity of the recirculating water. If a manual valve is used to control the rate of bleed it should be set to maintain the conductivity of the recirculating water during periods of peak load at the maximum level recommended by your water treatment company.

Water Treatment

The water treatment program prescribed for the given conditions must be compatible with the unit's materials of construction, including any galvanized components. The initial commissioning and passivation period is a critical time for maximizing the service life of galvanized equipment. EVAPCO recommends that the site specific water treatment protocol includes a passivation procedure which details water chemistry, any necessary chemical addition, and visual inspections during the first six (6) to twelve (12) weeks of operation. During this passivation period, recirculating water pH should be maintained above 7.0 and below 8.0 at all times. Batch feeding of chemicals is not recommended.

Control of Biological Contaminants

Evaporative cooling equipment should be inspected regularly to ensure good microbiological control. Inspections should include both monitoring of microbial populations via culturing techniques and visual inspections for evidence of biofouling. Poor microbiological control can result in loss of heat transfer efficiency, increase corrosion potential, and increase the risk of pathogens such as those that cause Legionnaires' disease. Your site specific water treatment protocol should include procedures for routine operation, startup after a shut-down period, and system lay-up, if applicable. If excessive microbiological contamination is detected, a more aggressive mechanical cleaning and/or water treatment program should be undertaken.

Models: LSWE 4-2F6 to 4-5J9

Closed Circuit Coolers

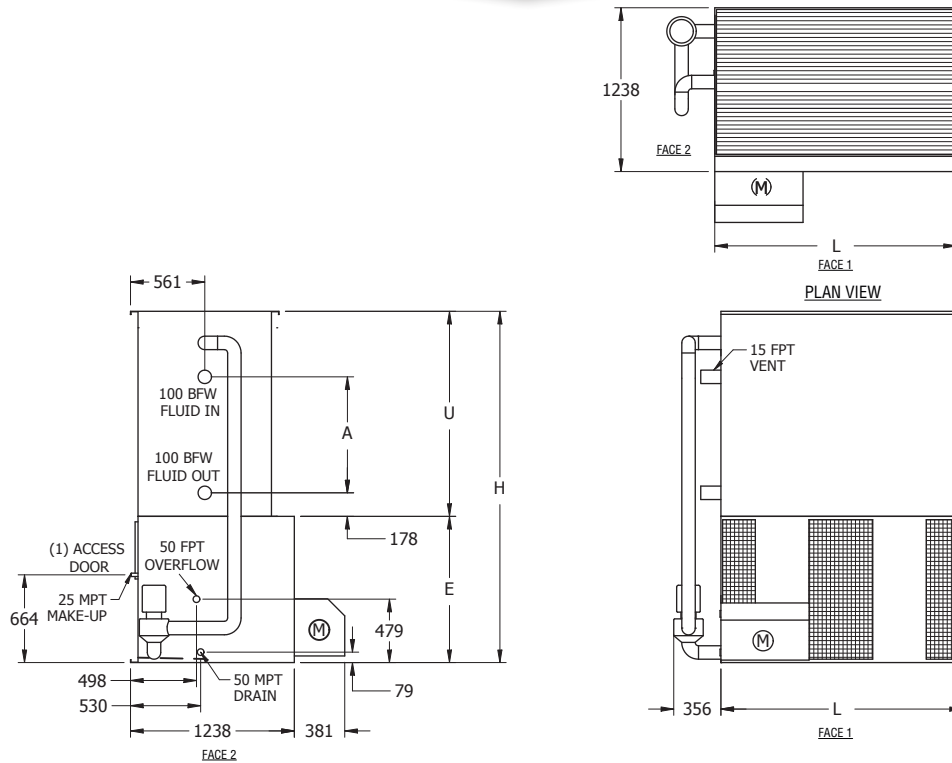

NOTE: The number of coil connections doubles when the flow rate exceeds 28 l/s on 4x6 and 4x9 models. This required option is referred to as the High Flow coil configuration.

Model No. †	Weights (kg)			Fans		Spray Pump		Coil Volume (Liters)	Remote sump Δ			Dimensions ▲				
	Shipping	Heaviest Section*	Operating	kW	m³/s	kW	l/s		Liters Req'd**	Conn. Size	Operating Weight (kg)	Height H	Length L	Lower E	Upper U	Coil A
LSWE 4-2F6	1070	558 ††	1492	2.2	4.8	0.55	7.6	126	303	100	1302	2083	1826	1105	978	305
LSWE 4-2G6	1075	558 ††	1497	4	5.7	0.55	7.6	126	303	100	1306	2083	1826	1105	978	305
LSWE 4-2H6	1098	558 ††	1520	5.5	6.6	0.55	7.6	126	303	100	1329	2083	1826	1105	978	305
LSWE 4-3F6	1234	721	1710	2.2	4.7	0.55	7.6	177	303	100	1515	2273	1826	1105	1168	496
LSWE 4-3G6	1238	721	1715	4	5.6	0.55	7.6	177	303	100	1520	2273	1826	1105	1168	496
LSWE 4-3H6	1261	721	1737	5.5	6.4	0.55	7.6	177	303	100	1542	2273	1826	1105	1168	496
LSWE 4-3I6	1270	721	1746	7.5	7.1	0.55	7.6	177	303	100	1551	2273	1826	1105	1168	496
LSWE 4-4F6	1393	880	1919	2.2	4.6	0.55	7.6	229	303	100	1724	2464	1826	1105	1359	686
LSWE 4-4G6	1397	880	1923	4	5.5	0.55	7.6	229	303	100	1728	2464	1826	1105	1359	686
LSWE 4-4H6	1420	880	1946	5.5	6.3	0.55	7.6	229	303	100	1751	2464	1826	1105	1359	686
LSWE 4-4I6	1429	880	1955	7.5	6.9	0.55	7.6	229	303	100	1760	2464	1826	1105	1359	686
LSWE 4-5G6	1560	1043	2136	4	5.4	0.55	7.6	280	303	100	1946	2654	1826	1105	1549	877
LSWE 4-5H6	1583	1043	2159	5.5	6.2	0.55	7.6	280	303	100	1969	2654	1826	1105	1549	877
LSWE 4-5I6	1592	1043	2168	7.5	6.8	0.55	7.6	280	303	100	1978	2654	1826	1105	1549	877
LSWE 4-3G9	1701	1025	2418	4	7.3	0.75	11.4	258	454	150	2168	2273	2724	1105	1168	496
LSWE 4-3H9	1724	1025	2440	5.5	8.4	0.75	11.4	258	454	150	2191	2273	2724	1105	1168	496
LSWE 4-3I9	1733	1025	2449	7.5	9.3	0.75	11.4	258	454	150	2200	2273	2724	1105	1168	496
LSWE 4-3J9	1787	1025	2504	11	10.6	0.75	11.4	258	454	150	2254	2273	2724	1105	1168	496
LSWE 4-4H9	1955	1256	2749	5.5	8.2	0.75	11.4	336	454	150	2499	2464	2724	1105	1359	686
LSWE 4-4I9	1964	1256	2758	7.5	9.1	0.75	11.4	336	454	150	2508	2464	2724	1105	1359	686
LSWE 4-4J9	2018	1256	2812	11	10.4	0.75	11.4	336	454	150	2563	2464	2724	1105	1359	686
LSWE 4-5H9	2195	1497	3071	5.5	8.1	0.75	11.4	414	454	150	2817	2654	2724	1105	1549	877
LSWE 4-5I9	2204	1497	3080	7.5	8.9	0.75	11.4	414	454	150	2826	2654	2724	1105	1549	877
LSWE 4-5J9	2259	1497	3134	11	10.2	0.75	11.4	414	454	150	2880	2654	2724	1105	1549	877

† Model Number will end in "-Z" for units with Series Flow piping configuration. Series Flow units may require additional coil connections and will require crossover piping. Model numbers will include "I" for units with Intake Attenuation, "D" for units with Discharge Attenuation, "F" for units with Full Sound Attenuation, "T" for units with a Tapered Discharge Hood, and "S" for units with an option that negates CTI Certification.

†† Model normally ships in one piece.

* Heaviest section is the coil section.

** Liters shown is water in suspension in unit and piping. Allow for additional water in bottom of remote sump to cover pump suction and strainer during operation (305 mm would normally be sufficient).

Δ When a remote sump arrangement is selected, the spray pump, suction strainer and associated piping are omitted; the unit is provided with an oversized outlet to facilitate drainage to the remote sump.

▲ Unit dimensions and coil connections may vary slightly from catalog. See factory certified prints for dimensions, quantity of coil connections, and piping configuration. Coil connections are 100 mm bevel for weld (BFW), also available as options. Other connection types such as grooved for mechanical coupling or flanged are also available as options.

Models: LSWE 4-3H12 to 4-5M18

Closed Circuit Coolers

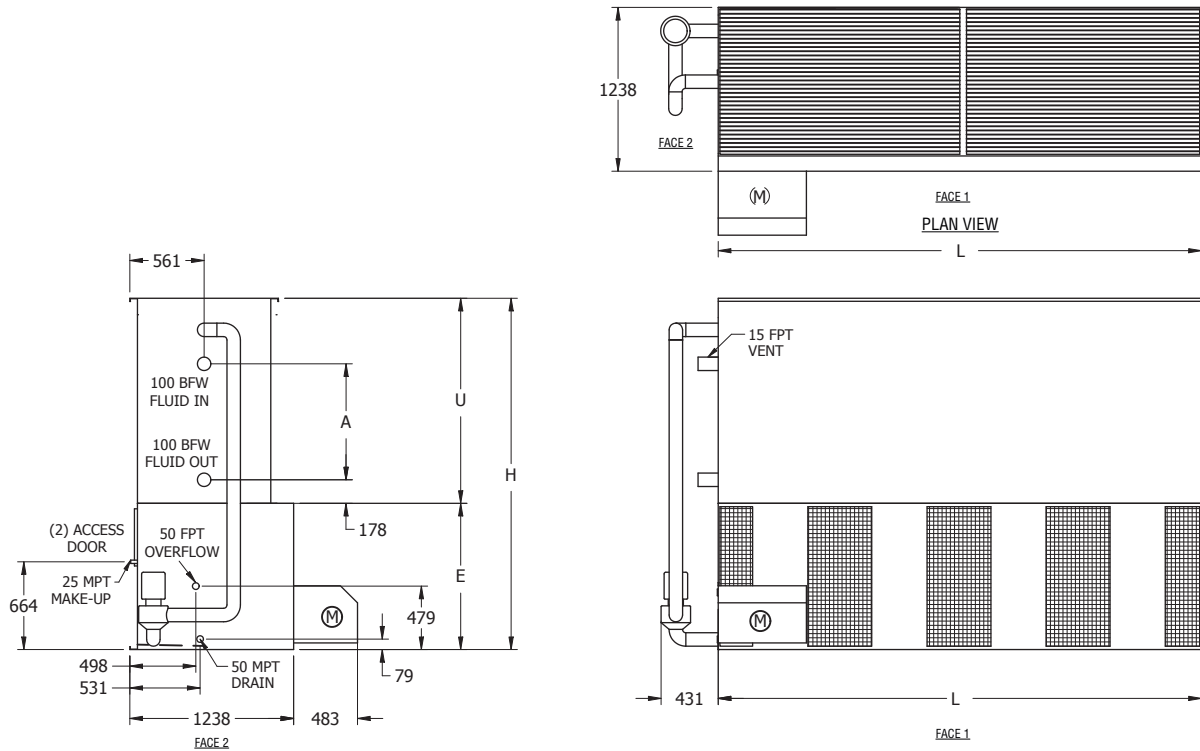

NOTE: The number of coil connections doubles when the flow rate exceeds 28 l/s on 4x6 and 4x9 models. This required option is referred to as the High Flow coil configuration.

Model No. †	Weights (kg)			Fans		Spray Pump		Coil Volume (Liters)	Remote sump Δ			Dimensions ▲				
	Shipping	Heaviest Section*	Operating	kW	m³/s	kW	l/s		Liters Req'd**	Conn. Size	Operating Weight (kg)	Height H	Length L	Lower E	Upper U	Coil A
LSWE 4-3H12	2254	1361	3171	5.5	10.2	1.1	15.5	338	643	150	2894	2273	3651	1105	1168	496
LSWE 4-3I12	2263	1361	3180	7.5	11.2	1.1	15.5	338	643	150	2903	2273	3651	1105	1168	496
LSWE 4-3J12	2318	1361	3234	11	12.9	1.1	15.5	338	643	150	2957	2273	3651	1105	1168	496
LSWE 4-3K12	2345	1361	3261	15	14.2	1.1	15.5	338	643	150	2985	2273	3651	1105	1168	496
LSWE 4-4I12	2576	1674	3597	7.5	11.0	1.1	15.5	443	643	150	3320	2464	3651	1105	1359	686
LSWE 4-4J12	2631	1674	3651	11	12.6	1.1	15.5	443	643	150	3375	2464	3651	1105	1359	686
LSWE 4-4K12	2658	1674	3679	15	13.9	1.1	15.5	443	643	150	3402	2464	3651	1105	1359	686
LSWE 4-5I12	2871	1969	3996	7.5	10.8	1.1	15.5	548	643	150	3733	2654	3651	1105	1549	877
LSWE 4-5J12	2926	1969	4051	11	12.4	1.1	15.5	548	643	150	3787	2654	3651	1105	1549	877
LSWE 4-5K12	2953	1969	4078	15	13.6	1.1	15.5	548	643	150	3815	2654	3651	1105	1549	877
LSWE 4-3I18	3252	2000	4568	7.5	14.8	1.5	23.1	499	946	200	4028	2273	5486	1105	1168	496
LSWE 4-3J18	3307	2000	4622	11	16.9	1.5	23.1	499	946	200	4082	2273	5486	1105	1168	496
LSWE 4-3K18	3334	2000	4649	15	18.6	1.5	23.1	499	946	200	4110	2273	5486	1105	1168	496
LSWE 4-3L18	3348	2000	4663	18.5	20.0	1.5	23.1	499	946	200	4123	2273	5486	1105	1168	496
LSWE 4-4J18	3765	2458	5239	11	16.6	1.5	23.1	657	946	200	4704	2464	5486	1105	1359	686
LSWE 4-4K18	3792	2458	5266	15	18.2	1.5	23.1	657	946	200	4731	2464	5486	1105	1359	686
LSWE 4-4L18	3806	2458	5280	18.5	19.6	1.5	23.1	657	946	200	4745	2464	5486	1105	1359	686
LSWE 4-5J18	4214	2908	5847	11	16.2	1.5	23.1	816	946	200	5312	2654	5486	1105	1549	877
LSWE 4-5K18	4241	2908	5874	15	17.9	1.5	23.1	816	946	200	5339	2654	5486	1105	1549	877
LSWE 4-5L18	4255	2908	5888	18.5	19.2	1.5	23.1	816	946	200	5352	2654	5486	1105	1549	877
LSWE 4-5M18	4277	2908	5910	22	20.4	1.5	23.1	816	946	200	5375	2654	5486	1105	1549	877

† Model Number will end in "-Z" for units with Series Flow piping configuration. Series Flow units may require additional coil connections and will require crossover piping. Model numbers will include "I" for units with Intake Attenuation, "D" for units with Discharge Attenuation, "F" for units with Full Sound Attenuation, "T" for units with a Tapered Discharge Hood, and "S" for units with an option that negates CTI Certification.

* Heaviest section is the coil section.

** Liters shown is water in suspension in unit and piping. Allow for additional water in bottom of remote sump to cover pump suction and strainer during operation (305 mm would normally be sufficient).

Δ When a remote sump arrangement is selected, the spray pump, suction strainer and associated piping are omitted; the unit is provided with an oversized outlet to facilitate drainage to the remote sump.

▲ Unit dimensions and coil connections may vary slightly from catalog. See factory certified prints for dimensions, quantity of coil connections, and piping configuration. Coil connections are 100 mm bevel for weld (BFW), also available as options. Other connection types such as grooved for mechanical coupling or flanged are also available as options.

Models: LSWE 5-3I12 to 5-7M12

Closed Circuit Coolers

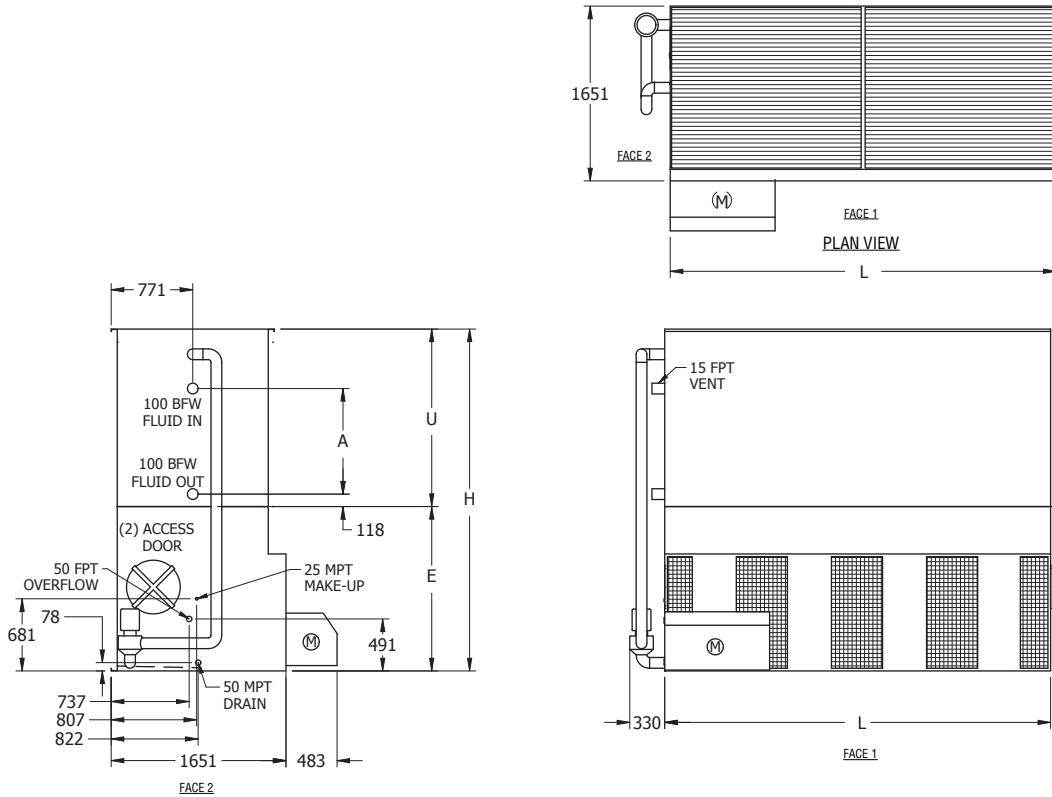

NOTE: The number of coil connections doubles when the flow rate exceeds 28 l/s on 5x12 models. This required option is referred to as the High Flow coil configuration.

Model No. †	Weights (kg)			Fans		Spray Pump		Coil Volume (Liters)	Remote sump Δ			Dimensions ▲				
	Shipping	Heaviest Section	Operating	kW	m³/s	kW	l/s		Liters Req'd**	Conn. Size	Operating Weight (kg)	Height H	Length L	Lower E	Upper U	Coil A
LSWE 5-3I12	2966	1801	4545	7.5	14.1	1.5	21.8	479	871	150	3765	2797	3645	1553	1245	566
LSWE 5-3J12	3021	1801	4599	11	16.2	1.5	21.8	479	871	150	3819	2797	3645	1553	1245	566
LSWE 5-3K12	3048	1801	4627	15	17.8	1.5	21.8	479	871	150	3846	2797	3645	1553	1245	566
LSWE 5-3L12	3062	1801	4640	18.5	19.2	1.5	21.8	479	871	150	3860	2797	3645	1553	1245	566
LSWE 5-4I12	3402	2236	5130	7.5	13.8	1.5	21.8	629	871	150	4364	3013	3645	1553	1461	782
LSWE 5-4J12	3456	2236	5185	11	15.8	1.5	21.8	629	871	150	4418	3013	3645	1553	1461	782
LSWE 5-4K12	3484	2236	5212	15	17.4	1.5	21.8	629	871	150	4445	3013	3645	1553	1461	782
LSWE 5-4L12	3497	2236	5225	18.5	18.8	1.5	21.8	629	871	150	4459	3013	3645	1553	1461	782
LSWE 5-5J12	3910	2690	5788	11	15.5	1.5	21.8	778	871	150	5026	3229	3645	1553	1676	997
LSWE 5-5K12	3937	2690	5815	15	17.1	1.5	21.8	778	871	150	5053	3229	3645	1553	1676	997
LSWE 5-5L12	3951	2690	5829	18.5	18.4	1.5	21.8	778	871	150	5067	3229	3645	1553	1676	997
LSWE 5-6J12	4354	3134	6382	11	15.2	1.5	21.8	928	871	150	5625	3445	3645	1553	1892	1213
LSWE 5-6K12	4382	3134	6409	15	16.7	1.5	21.8	928	871	150	5652	3445	3645	1553	1892	1213
LSWE 5-6L12	4395	3134	6423	18.5	18.0	1.5	21.8	928	871	150	5665	3445	3645	1553	1892	1213
LSWE 5-6M12	4418	3134	6446	22	19.2	1.5	21.8	928	871	150	5688	3445	3645	1553	1892	1213
LSWE 5-7J12	4863	3642	7040	11	14.9	1.5	21.8	1077	871	150	6282	3445	3645	1553	1892	1213
LSWE 5-7K12	4890	3642	7067	15	16.4	1.5	21.8	1077	871	150	6309	3445	3645	1553	1892	1213
LSWE 5-7L12	4903	3642	7081	18.5	17.7	1.5	21.8	1077	871	150	6323	3445	3645	1553	1892	1213
LSWE 5-7M12	4926	3642	7103	22	18.8	1.5	21.8	1077	871	150	6346	3445	3645	1553	1892	1213

† Model Number will end in "-Z" for units with Series Flow piping configuration. Series Flow units may require additional coil connections and will require crossover piping. Model numbers will include "I" for units with Intake Attenuation, "D" for units with Discharge Attenuation, "F" for units with Full Sound Attenuation, "T" for units with a Tapered Discharge Hood, and "S" for units with an option that negates CTI Certification.

* Heaviest section is the coil section.

** Liters shown is water in suspension in unit and piping. Allow for additional water in bottom of remote sump to cover pump suction and strainer during operation (305 mm would normally be sufficient).

Δ When a remote sump arrangement is selected, the spray pump, suction strainer and associated piping are omitted; the unit is provided with an oversized outlet to facilitate drainage to the remote sump.

▲ Unit dimensions and coil connections may vary slightly from catalog. See factory certified prints for dimensions, quantity of coil connections, and piping configuration. Coil connections are 100 mm bevel for weld (BFW), also available as options. Other connection types such as grooved for mechanical coupling or flanged are also available as options.

Models: LSWE 5-3J18 to 5-7N18

Closed Circuit Coolers

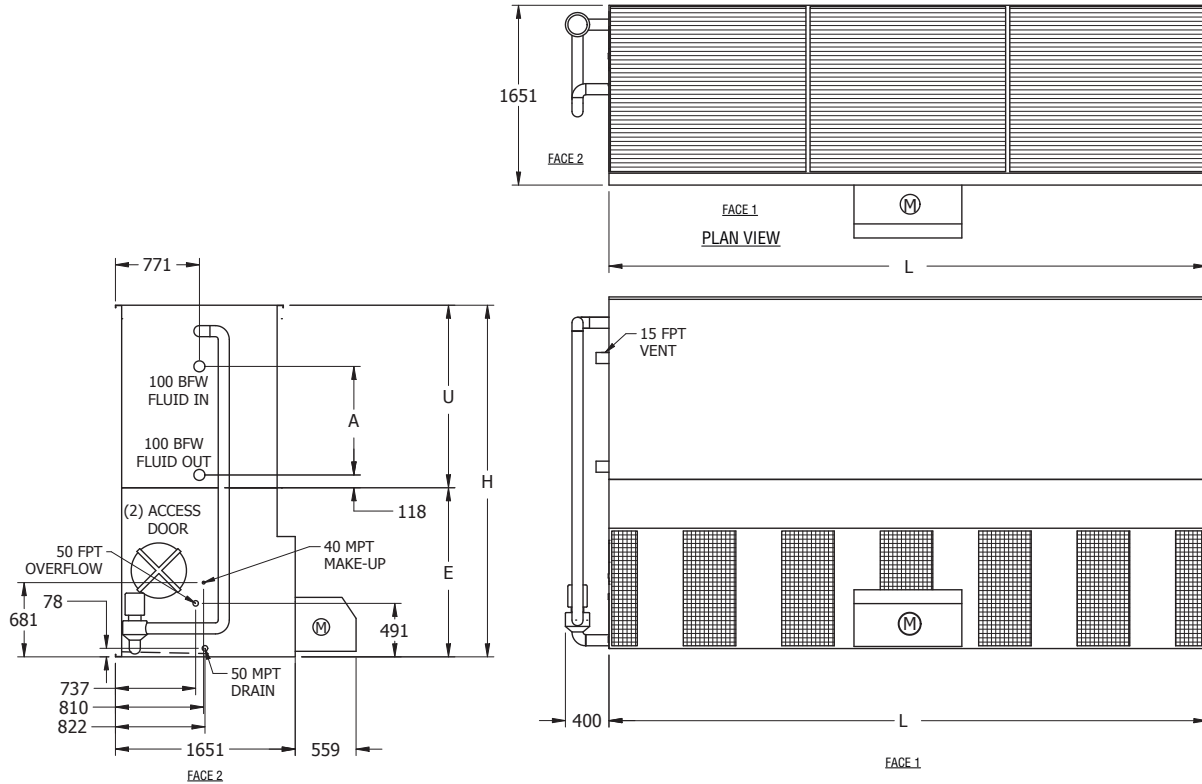

NOTE: The number of coil connections doubles when the flow rate exceeds 28 l/s on 5x18 models. This required option is referred to as the High Flow coil configuration.

Model No. †	Weights (kg)			Fans		Spray Pump		Coil Volume (Liters)	Remote sump Δ			Dimensions ▲				
	Shipping	Heaviest Section*	Operating	kW	m ³ /s	kW	l/s		Liters Req'd**	Conn. Size	Operating Weight (kg)	Height H	Length L	Lower E	Upper U	Coil A
LSWE 5-3J18	4459	2699	6722	11	21.2	2.2	32.5	708	1287	200	5371	2797	5483	1553	1245	566
LSWE 5-3K18	4486	2699	6749	15	23.4	2.2	32.5	708	1287	200	5398	2797	5483	1553	1245	566
LSWE 5-3L18	4500	2699	6763	18.5	25.2	2.2	32.5	708	1287	200	5411	2797	5483	1553	1245	566
LSWE 5-3M18	4522	2699	6786	22	26.7	2.2	32.5	708	1287	200	5434	2797	5483	1553	1245	566
LSWE 5-4K18	5139	3352	7625	15	22.9	2.2	32.5	934	1287	200	6273	3013	5483	1553	1461	782
LSWE 5-4L18	5153	3352	7638	18.5	24.7	2.2	32.5	934	1287	200	6287	3013	5483	1553	1461	782
LSWE 5-4M18	5175	3352	7661	22	26.2	2.2	32.5	934	1287	200	6309	3013	5483	1553	1461	782
LSWE 5-4N18	5248	3352	7734	30	28.8	2.2	32.5	934	1287	200	6382	3013	5483	1553	1461	782
LSWE 5-5K18	5824	4037	8537	15	22.4	2.2	32.5	1160	1287	200	7194	3229	5483	1553	1676	997
LSWE 5-5L18	5838	4037	8550	18.5	24.2	2.2	32.5	1160	1287	200	7208	3229	5483	1553	1676	997
LSWE 5-5M18	5860	4037	8573	22	25.7	2.2	32.5	1160	1287	200	7230	3229	5483	1553	1676	997
LSWE 5-5N18	5933	4037	8645	30	28.3	2.2	32.5	1160	1287	200	7303	3229	5483	1553	1676	997
LSWE 5-6L18	6505	4704	9444	18.5	23.7	2.2	32.5	1386	1287	200	8115	3445	5483	1553	1892	1213
LSWE 5-6M18	6527	4704	9466	22	25.2	2.2	32.5	1386	1287	200	8137	3445	5483	1553	1892	1213
LSWE 5-6N18	6600	4704	9539	30	27.7	2.2	32.5	1386	1287	200	8210	3445	5483	1553	1892	1213
LSWE 5-7L18	7271	5470	10437	18.5	23.2	2.2	32.5	1611	1287	200	9104	3445	5483	1553	1892	1213
LSWE 5-7M18	7294	5470	10460	22	24.6	2.2	32.5	1611	1287	200	9126	3445	5483	1553	1892	1213
LSWE 5-7N18	7366	5470	10532	30	27.1	2.2	32.5	1611	1287	200	9199	3445	5483	1553	1892	1213

† Model Number will end in "-Z" for units with Series Flow piping configuration. Series Flow units may require additional coil connections and will require crossover piping. Model numbers will include "I" for units with Intake Attenuation, "D" for units with Discharge Attenuation, "F" for units with Full Sound Attenuation, "T" for units with a Tapered Discharge Hood, and "S" for units with an option that negates CTI Certification.

* Heaviest section is the coil section.

** Liters shown is water in suspension in unit and piping. Allow for additional water in bottom of remote sump to cover pump suction and strainer during operation (305 mm would normally be sufficient).

Δ When a remote sump arrangement is selected, the spray pump, suction strainer and associated piping are omitted; the unit is provided with an oversized outlet to facilitate drainage to the remote sump.

▲ Unit dimensions and coil connections may vary slightly from catalog. See factory certified prints for dimensions, quantity of coil connections, and piping configuration. Coil connections are 100 mm bevel for weld (BFW), also available as options. Other connection types such as grooved for mechanical coupling or flanged are also available as options.

Models: LSWE 8P-3K12 to 8P-7O12

Closed Circuit Coolers

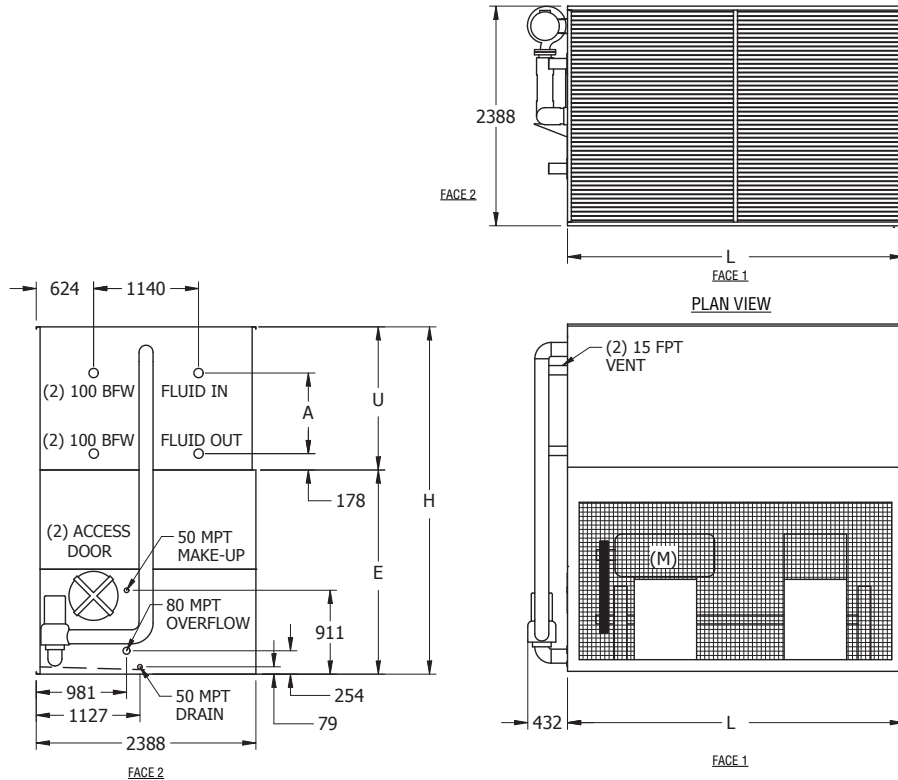

NOTE: The number of coil connections doubles when the flow rate exceeds 56 l/s on 8Px12 models. This required option is referred to as the High Flow coil configuration.

Model No. †	Weights (kg)			Fans		Spray Pump		Coil Volume (Liters)	Remote sump Δ			Dimensions ▲				
	Shipping	Heaviest Section *	Operating	kW	m ³ /s	kW	l/s		Liters Req'd**	Conn. Size	Operating Weight (kg)	Height H	Length L	Lower E	Upper U	Coil A
LSWE 8P-3K12	4382	2663	6668	15	22.9	4	36.0	756	1363	250	5774	3394	3651	2219	1175	496
LSWE 8P-3L12	4395	2663	6681	18.5	24.7	4	36.0	756	1363	250	5788	3394	3651	2219	1175	496
LSWE 8P-3M12	4418	2663	6704	22	26.3	4	36.0	756	1363	250	5811	3394	3651	2219	1175	496
LSWE 8P-3N12	4491	2663	6777	30	28.9	4	36.0	756	1363	250	5883	3394	3651	2219	1175	496
LSWE 8P-4L12	5058	3325	7580	18.5	24.2	4	36.0	991	1363	250	6736	3585	3651	2219	1365	686
LSWE 8P-4M12	5080	3325	7602	22	25.8	4	36.0	991	1363	250	6759	3585	3651	2219	1365	686
LSWE 8P-4N12	5153	3325	7675	30	28.3	4	36.0	991	1363	250	6831	3585	3651	2219	1365	686
LSWE 8P-4O12	5157	3325	7679	37	30.5	4	36.0	991	1363	250	6836	3585	3651	2219	1365	686
LSWE 8P-5M12	5720	3964	8478	22	25.2	4	36.0	1227	1363	250	7684	3775	3651	2219	1556	877
LSWE 8P-5N12	5792	3964	8550	30	27.8	4	36.0	1227	1363	250	7756	3775	3651	2219	1556	877
LSWE 8P-5O12	5797	3964	8555	37	29.9	4	36.0	1227	1363	250	7761	3775	3651	2219	1556	877
LSWE 8P-6M12	6382	4627	9376	22	24.7	4	36.0	1462	1363	250	8636	3966	3651	2219	1746	1067
LSWE 8P-6N12	6455	4627	9448	30	27.2	4	36.0	1462	1363	250	8709	3966	3651	2219	1746	1067
LSWE 8P-6O12	6459	4627	9453	37	29.3	4	36.0	1462	1363	250	8714	3966	3651	2219	1746	1067
LSWE 8P-7M12	7053	5298	10283	22	24.2	4	36.0	1697	1363	250	9544	4016	3651	2219	1797	1213
LSWE 8P-7N12	7126	5298	10356	30	26.6	4	36.0	1697	1363	250	9616	4016	3651	2219	1797	1213
LSWE 8P-7O12	7130	5298	10360	37	28.7	4	36.0	1697	1363	250	9621	4016	3651	2219	1797	1213

† Model Number will end in "-Z" for units with Series Flow piping configuration. Series Flow units may require additional coil connections and will require crossover piping. Model numbers will include "I" for units with Intake Attenuation, "D" for units with Discharge Attenuation, "F" for units with Full Sound Attenuation, "T" for units with a Tapered Discharge Hood, and "S" for units with an option that negates CTI Certification.

* Heaviest section is the coil section.

** Liters shown is water in suspension in unit and piping. Allow for additional water in bottom of remote sump to cover pump suction and strainer during operation (305 mm would normally be sufficient).

Δ When a remote sump arrangement is selected, the spray pump, suction strainer and associated piping are omitted; the unit is provided with an oversized outlet to facilitate drainage to the remote sump.

▲ Unit dimensions and coil connections may vary slightly from catalog. See factory certified prints for dimensions, quantity of coil connections, and piping configuration. Coil connections are 100 mm bevel for weld (BFW), also available as options. Other connection types such as grooved for mechanical coupling or flanged are also available as options.

Models: LSWE 8P-3M18 to 8P-7P18

Closed Circuit Coolers

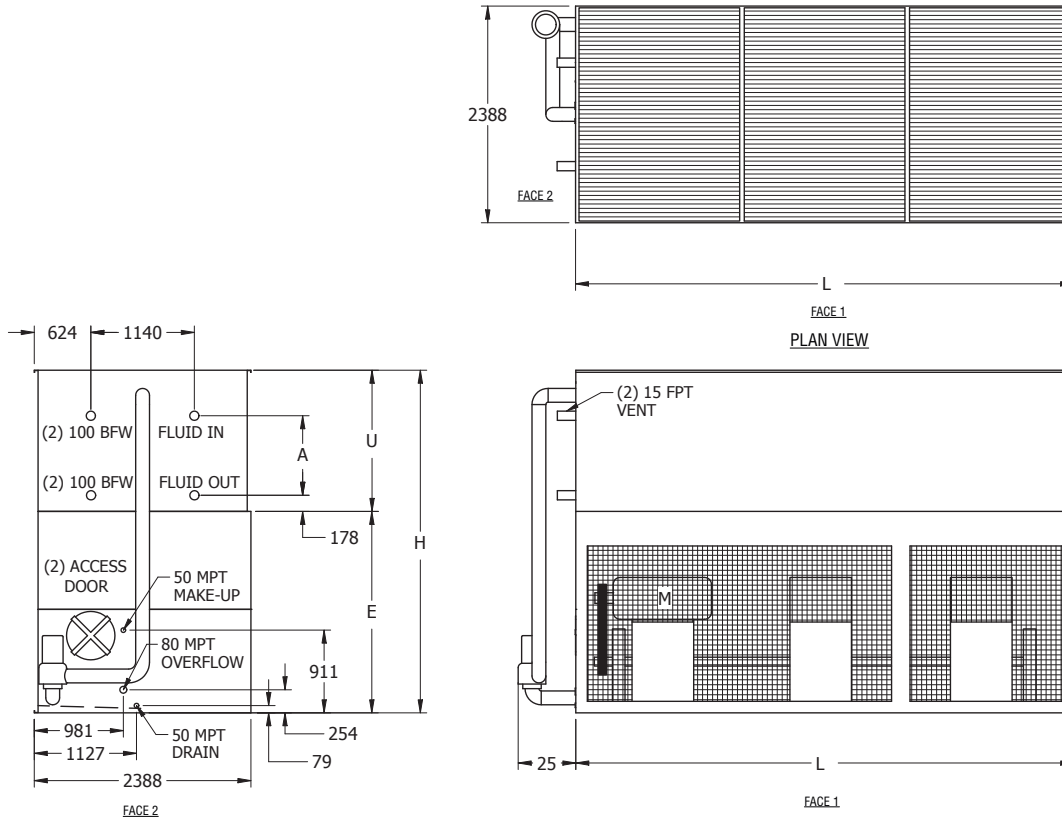

NOTE: The number of coil connections doubles when the flow rate exceeds 56 l/s on 8Px18 models. This required option is referred to as the High Flow coil configuration.

Model No. †	Weights (kg)			Fans		Spray Pump		Coil Volume (Liters)	Remote sump Δ			Dimensions ▲				
	Shipping	Heaviest Section*	Operating	kW	m³/s	kW	l/s		Liters Req'd**	Conn. Size	Operating Weight (kg)	Height H	Length L	Lower E	Upper U	Coil A
LSWE 8P-3M18	6323	3946	9770	22	34.3	5.5	53.0	1117	2006	300	8455	3394	5486	2219	1175	496
LSWE 8P-3N18	6396	3946	9843	30	37.8	5.5	53.0	1117	2006	300	8528	3394	5486	2219	1175	496
LSWE 8P-3O18	6400	3946	9847	37	40.7	5.5	53.0	1117	2006	300	8532	3394	5486	2219	1175	496
LSWE 8P-3P18	6491	3946	9938	45	43.3	5.5	53.0	1117	2006	300	8623	3394	5486	2219	1175	496
LSWE 8P-4M18	7316	4940	11118	22	33.7	5.5	53.0	1472	2006	300	9884	3585	5486	2219	1365	686
LSWE 8P-4N18	7389	4940	11190	30	37.1	5.5	53.0	1472	2006	300	9956	3585	5486	2219	1365	686
LSWE 8P-4O18	7394	4940	11195	37	39.9	5.5	53.0	1472	2006	300	9961	3585	5486	2219	1365	686
LSWE 8P-4P18	7484	4940	11285	45	42.4	5.5	53.0	1472	2006	300	10052	3585	5486	2219	1365	686
LSWE 8P-5N18	8337	5888	12492	30	36.3	5.5	53.0	1827	2006	300	11335	3775	5486	2219	1556	877
LSWE 8P-5O18	8342	5888	12496	37	39.1	5.5	53.0	1827	2006	300	11340	3775	5486	2219	1556	877
LSWE 8P-5P18	8432	5888	12587	45	41.6	5.5	53.0	1827	2006	300	11431	3775	5486	2219	1556	877
LSWE 8P-6N18	9344	6895	13857	30	35.6	5.5	53.0	2183	2006	300	12773	3966	5486	2219	1746	1067
LSWE 8P-6O18	9349	6895	13862	37	38.3	5.5	53.0	2183	2006	300	12778	3966	5486	2219	1746	1067
LSWE 8P-6P18	9439	6895	13952	45	40.7	5.5	53.0	2183	2006	300	12868	3966	5486	2219	1746	1067
LSWE 8P-7N18	10337	7888	15204	30	34.8	5.5	53.0	2538	2006	300	14120	4016	5486	2219	1797	1213
LSWE 8P-7O18	10342	7888	15209	37	37.5	5.5	53.0	2538	2006	300	14125	4016	5486	2219	1797	1213
LSWE 8P-7P18	10433	7888	15300	45	39.9	5.5	53.0	2538	2006	300	14216	4016	5486	2219	1797	1213

† Model Number will end in "-Z" for units with Series Flow piping configuration. Series Flow units may require additional coil connections and will require crossover piping. Model numbers will include "I" for units with Intake Attenuation, "D" for units with Discharge Attenuation, "F" for units with Full Sound Attenuation, "T" for units with a Tapered Discharge Hood, and "S" for units with an option that negates CTI Certification.

* Heaviest section is the coil section.

** Liters shown is water in suspension in unit and piping. Allow for additional water in bottom of remote sump to cover pump suction and strainer during operation (305 mm would normally be sufficient).

Δ When a remote sump arrangement is selected, the spray pump, suction strainer and associated piping are omitted; the unit is provided with an oversized outlet to facilitate drainage to the remote sump.

▲ Unit dimensions and coil connections may vary slightly from catalog. See factory certified prints for dimensions, quantity of coil connections, and piping configuration. Coil connections are 100 mm bevel for weld (BFW), also available as options. Other connection types such as grooved for mechanical coupling or flanged are also available as options.

Models: LSWE 8P-3K24 to 8P-7O24

Closed Circuit Coolers

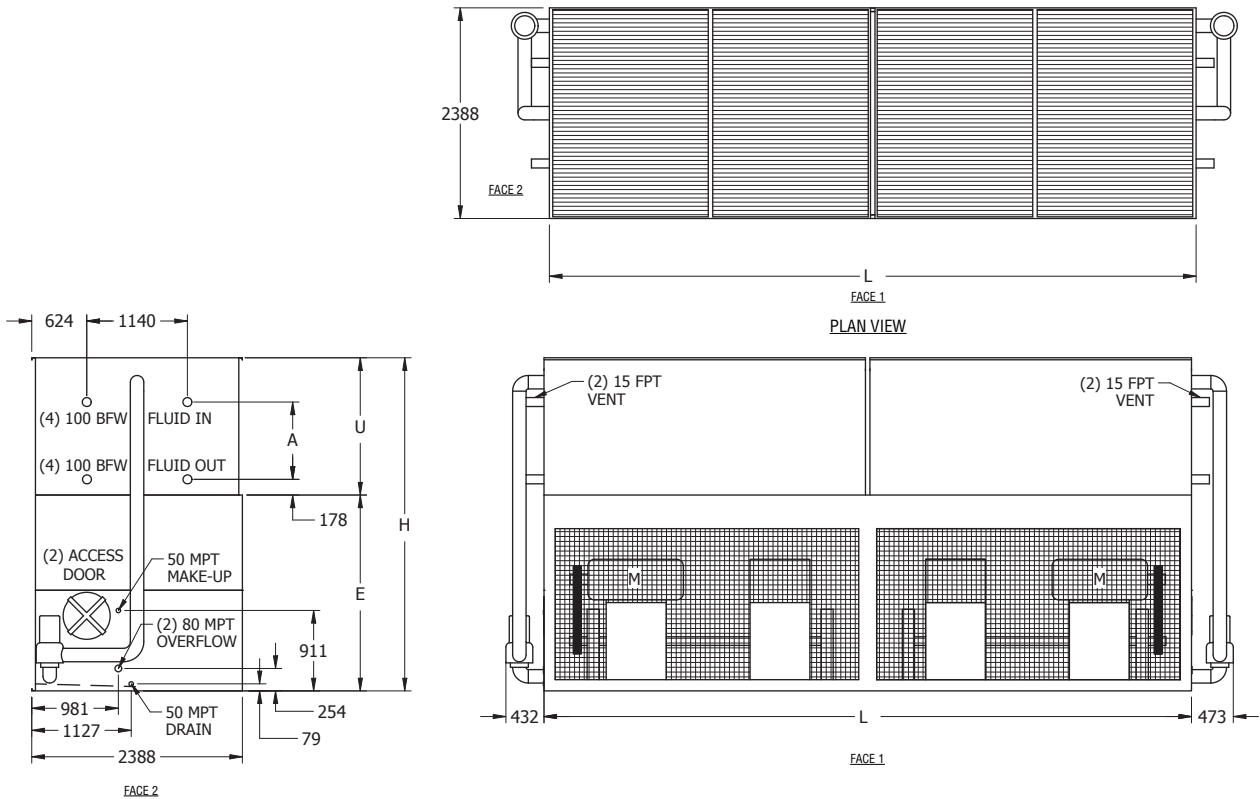

NOTE: The number of coil connections doubles when the flow rate exceeds 113 l/s on 8Px24 models. This required option is referred to as the High Flow coil configuration.

Model No. †	Weights (kg)			Fans		Spray Pump		Coil Volume (Liters)	Remote sump Δ			Dimensions ▲				
	Shipping	Heaviest Section	Operating	kW	m³/s	kW	l/s		Liters Req'd**	Conn. Size	Operating Weight (kg)	Height H	Length L	Lower E	Upper U	Coil A
LSWE 8P-3K24	8455	3130#	13059	(2) 15	45.9	(2) 4	72.0	1512	2725	(2) 250	11635	3394	7341	2219	1175	496
LSWE 8P-3L24	8482	3157#	13086	(2) 18.5	49.4	(2) 4	72.0	1512	2725	(2) 250	11689	3394	7341	2219	1175	496
LSWE 8P-3M24	8528	3202††#	13131	(2) 22	52.5	(2) 4	72.0	1512	2725	(2) 250	11780	3394	7341	2219	1175	496
LSWE 8P-3N24	8673	3348††#	13277	(2) 30	57.8	(2) 4	72.0	1512	2725	(2) 250	12070	3394	7341	2219	1175	496
LSWE 8P-4L24	9798	3320	14873	(2) 18.5	48.5	(2) 4	72.0	1983	2725	(2) 250	13594	3585	7341	2219	1365	686
LSWE 8P-4M24	9843	3320	14919	(2) 22	51.5	(2) 4	72.0	1983	2725	(2) 250	13685	3585	7341	2219	1365	686
LSWE 8P-4N24	9988	3348#	15064	(2) 30	56.7	(2) 4	72.0	1983	2725	(2) 250	13975	3585	7341	2219	1365	686
LSWE 8P-4O24	9997	3357#	15073	(2) 37	61.1	(2) 4	72.0	1983	2725	(2) 250	13993	3585	7341	2219	1365	686
LSWE 8P-5M24	11131	3964	16679	(2) 22	50.5	(2) 4	72.0	2453	2725	(2) 250	15540	3775	7341	2219	1556	877
LSWE 8P-5N24	11276	3964	16824	(2) 30	55.6	(2) 4	72.0	2453	2725	(2) 250	15830	3775	7341	2219	1556	877
LSWE 8P-5O24	11285	3964	16833	(2) 37	59.8	(2) 4	72.0	2453	2725	(2) 250	15849	3775	7341	2219	1556	877
LSWE 8P-6M24	12456	4627	18475	(2) 22	49.4	(2) 4	72.0	2924	2725	(2) 250	17450	3966	7341	2219	1746	1067
LSWE 8P-6N24	12601	4627	18620	(2) 30	54.4	(2) 4	72.0	2924	2725	(2) 250	17740	3966	7341	2219	1746	1067
LSWE 8P-6O24	12610	4627	18629	(2) 37	58.6	(2) 4	72.0	2924	2725	(2) 250	17758	3966	7341	2219	1746	1067
LSWE 8P-7M24	13798	5298	20289	(2) 22	48.4	(2) 4	72.0	3395	2725	(2) 250	19264	4016	7341	2219	1797	1213
LSWE 8P-7N24	13943	5298	20434	(2) 30	53.3	(2) 4	72.0	3395	2725	(2) 250	19554	4016	7341	2219	1797	1213
LSWE 8P-7O24	13952	5298	20443	(2) 37	57.4	(2) 4	72.0	3395	2725	(2) 250	19572	4016	7341	2219	1797	1213

† Model Number will end in "-Z" for units with Series Flow piping configuration. Series Flow units may require additional coil connections and will require crossover piping. Model numbers will include "I" for units with Intake Attenuation, "D" for units with Discharge Attenuation, "F" for units with Full Sound Attenuation, "T" for units with a Tapered Discharge Hood, and "S" for units with an option that negates CTI Certification.

†† Model normally ships in one piece.

* Heaviest section is the coil section.

** Liters shown is water in suspension in unit and piping. Allow for additional water in bottom of remote sump to cover pump suction and strainer during operation (305 mm would normally be sufficient).

Heaviest section is the basin section.

Δ When a remote sump arrangement is selected, the spray pump, suction strainer and associated piping are omitted; the unit is provided with an oversized outlet to facilitate drainage to the remote sump.

▲ Unit dimensions and coil connections may vary slightly from catalog. See factory certified prints for dimensions, quantity of coil connections, and piping configuration. Coil connections are 100 mm bevel for weld (BFW), also available as options. Other connection types such as grooved for mechanical coupling or flanged are also available as options.

Models: LSWE 8P-3M36 to 8P-7P36

Closed Circuit Coolers

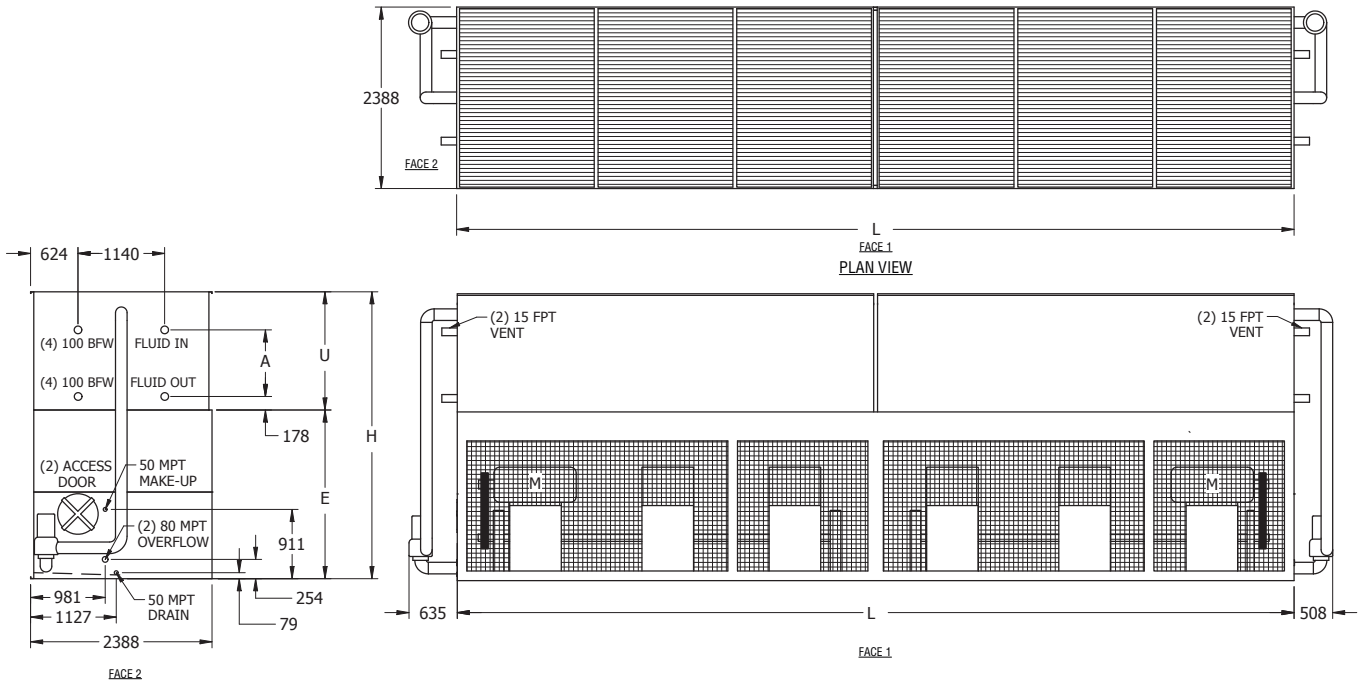

NOTE: The number of coil connections doubles when the flow rate exceeds 113 l/s on 8Px36 models. This required option is referred to as the High Flow coil configuration.

Model No. †	Weights (kg)			Fans		Spray Pump		Coil Volume (Liters)	Remote sump Δ			Dimensions ▲				
	Shipping	Heaviest Section*	Operating	kW	m³/s	kW	l/s		Liters Req'd**	Conn. Size	Operating Weight (kg)	Height H	Length L	Lower E	Upper U	Coil A
LSWE 8P-3M36	12306	4413#	19246	(2) 22	68.7	(2) 5.5	106.0	2233	4012	(2) 300	17073	3394	11024	2219	1175	496
LSWE 8P-3N36	12451	4559#	19391	(2) 30	75.6	(2) 5.5	106.0	2233	4012	(2) 300	17364	3394	11024	2219	1175	496
LSWE 8P-3O36	12460	4568#	19400	(2) 37	81.4	(2) 5.5	106.0	2233	4012	(2) 300	17382	3394	11024	2219	1175	496
LSWE 8P-3P36	12642	4749††#	19582	(2) 45	86.5	(2) 5.5	106.0	2233	4012	(2) 300	17745	3394	11024	2219	1175	496
LSWE 8P-4M36	14302	4944	21949	(2) 22	67.3	(2) 5.5	106.0	2944	4012	(2) 300	19931	3585	11024	2219	1365	686
LSWE 8P-4N36	14447	4944	22094	(2) 30	74.1	(2) 5.5	106.0	2944	4012	(2) 300	20221	3585	11024	2219	1365	686
LSWE 8P-4O36	14456	4944	22104	(2) 37	79.8	(2) 5.5	106.0	2944	4012	(2) 300	20239	3585	11024	2219	1365	686
LSWE 8P-4P36	14637	4944	22285	(2) 45	84.8	(2) 5.5	106.0	2944	4012	(2) 300	20602	3585	11024	2219	1365	686
LSWE 8P-5N36	16352	5897	24707	(2) 30	72.6	(2) 5.5	106.0	3655	4012	(2) 300	23002	3775	11024	2219	1556	877
LSWE 8P-5O36	16361	5897	24716	(2) 37	78.2	(2) 5.5	106.0	3655	4012	(2) 300	23020	3775	11024	2219	1556	877
LSWE 8P-5P36	16543	5897	24898	(2) 45	83.2	(2) 5.5	106.0	3655	4012	(2) 300	23383	3775	11024	2219	1556	877
LSWE 8P-6N36	18348	6895	27420	(2) 30	71.2	(2) 5.5	106.0	4366	4012	(2) 300	25859	3966	11024	2219	1746	1067
LSWE 8P-6O36	18357	6895	27429	(2) 37	76.7	(2) 5.5	106.0	4366	4012	(2) 300	25877	3966	11024	2219	1746	1067
LSWE 8P-6P36	18538	6895	27610	(2) 45	81.5	(2) 5.5	106.0	4366	4012	(2) 300	26240	3966	11024	2219	1746	1067
LSWE 8P-7N36	20335	7888	30114	(2) 30	69.7	(2) 5.5	106.0	5076	4012	(2) 300	28558	4016	11024	2219	1797	1213
LSWE 8P-7O36	20344	7888	30123	(2) 37	75.1	(2) 5.5	106.0	5076	4012	(2) 300	28576	4016	11024	2219	1797	1213
LSWE 8P-7P36	20525	7888	30304	(2) 45	79.8	(2) 5.5	106.0	5076	4012	(2) 300	28939	4016	11024	2219	1797	1213

† Model Number will end in "-Z" for units with Series Flow piping configuration. Series Flow units may require additional coil connections and will require crossover piping. Model numbers will include "I" for units with Intake Attenuation, "D" for units with Discharge Attenuation, "F" for units with Full Sound Attenuation, "T" for units with a Tapered Discharge Hood, and "S" for units with an option that negates CTI Certification.

†† Model normally ships in one piece.

* Heaviest section is the coil section.

** Liters shown is water in suspension in unit and piping. Allow for additional water in bottom of remote sump to cover pump suction and strainer during operation (305 mm would normally be sufficient).

Heaviest section is the basin section.

Δ When a remote sump arrangement is selected, the spray pump, suction strainer and associated piping are omitted; the unit is provided with an oversized outlet to facilitate drainage to the remote sump.

▲ Unit dimensions and coil connections may vary slightly from catalog. See factory certified prints for dimensions, quantity of coil connections, and piping configuration. Coil connections are 100 mm bevel for weld (BFW), also available as options. Other connection types such as grooved for mechanical coupling or flanged are also available as options.

Models: LSWE Models 10-3M12 to 10-7P12

Closed Circuit Coolers

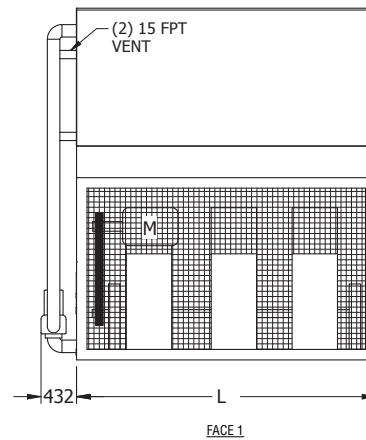
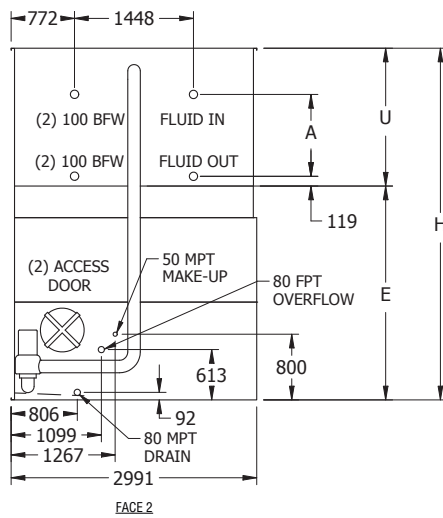
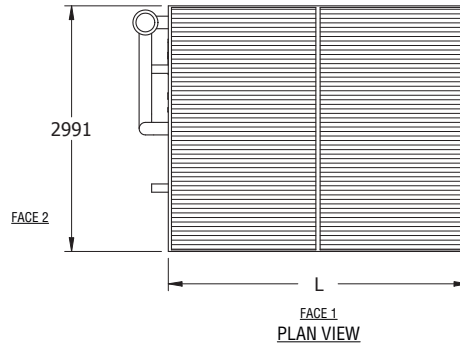

NOTE: The number of coil connections doubles when the flow rate exceeds 56 l/s on 10x12 models. This required option is referred to as the High Flow coil configuration.

Model No. †	Weights (kg)			Fans		Spray Pump		Coil Volume (Liters)	Remote sump Δ			Dimensions ▲				
	Shipping	Heaviest Section*	Operating	kW	m³/s	kW	l/s		Liters Req'd**	Conn. Size	Operating Weight (kg)	Height H	Length L	Lower E	Upper U	Coil A
LSWE 10-3M12	5792	3574	8727	22	32.3	4	43.3	959	1552	250	7707	3851	3651	2604	1248	566
LSWE 10-3N12	5865	3574	8800	30	35.5	4	43.3	959	1552	250	7779	3851	3651	2604	1248	566
LSWE 10-3O12	5869	3574	8804	37	38.3	4	43.3	959	1552	250	7784	3851	3651	2604	1248	566
LSWE 10-4M12	6663	4445	9897	22	31.6	4	43.3	1258	1552	250	8958	4067	3651	2604	1464	782
LSWE 10-4N12	6736	4445	9970	30	34.8	4	43.3	1258	1552	250	9031	4067	3651	2604	1464	782
LSWE 10-4O12	6740	4445	9974	37	37.5	4	43.3	1258	1552	250	9036	4067	3651	2604	1464	782
LSWE 10-5M12	7484	5266	11018	22	31.0	4	43.3	1557	1552	250	10156	4283	3651	2604	1680	997
LSWE 10-5N12	7557	5266	11090	30	34.1	4	43.3	1557	1552	250	10228	4283	3651	2604	1680	997
LSWE 10-5O12	7561	5266	11095	37	36.8	4	43.3	1557	1552	250	10233	4283	3651	2604	1680	997
LSWE 10-6M12	8346	6128	12174	22	30.4	4	43.3	1855	1552	250	11394	4499	3651	2604	1895	1213
LSWE 10-6N12	8419	6128	12247	30	33.4	4	43.3	1855	1552	250	11467	4499	3651	2604	1895	1213
LSWE 10-6O12	8423	6128	12252	37	36.0	4	43.3	1855	1552	250	11471	4499	3651	2604	1895	1213
LSWE 10-6P12	8514	6128	12342	45	38.3	4	43.3	1855	1552	250	11562	4499	3651	2604	1895	1213
LSWE 10-7M12	9362	7144	13490	22	29.7	4	43.3	2154	1552	250	12710	4499	3651	2604	1895	1213
LSWE 10-7N12	9435	7144	13562	30	32.7	4	43.3	2154	1552	250	12782	4499	3651	2604	1895	1213
LSWE 10-7O12	9439	7144	13567	37	35.3	4	43.3	2154	1552	250	12787	4499	3651	2604	1895	1213
LSWE 10-7P12	9530	7144	13658	45	37.5	4	43.3	2154	1552	250	12877	4499	3651	2604	1895	1213

† Model Number will end in "-Z" for units with Series Flow piping configuration. Series Flow units may require additional coil connections and will require crossover piping. Model numbers will include "I" for units with Intake Attenuation, "D" for units with Discharge Attenuation, "F" for units with Full Sound Attenuation, "T" for units with a Tapered Discharge Hood, and "S" for units with an option that negates CTI Certification.

* Heaviest section is the coil section.

** Liters shown is water in suspension in unit and piping. Allow for additional water in bottom of remote sump to cover pump suction and strainer during operation (305 mm would normally be sufficient).

Δ When a remote sump arrangement is selected, the spray pump, suction strainer and associated piping are omitted; the unit is provided with an oversized outlet to facilitate drainage to the remote sump.

▲ Unit dimensions and coil connections may vary slightly from catalog. See factory certified prints for dimensions, quantity of coil connections, and piping configuration. Coil connections are 100 mm bevel for weld (BFW), also available as options. Other connection types such as grooved for mechanical coupling or flanged are also available as options.

Models: LSWE 10-3K18 to 10-7N18

Closed Circuit Coolers

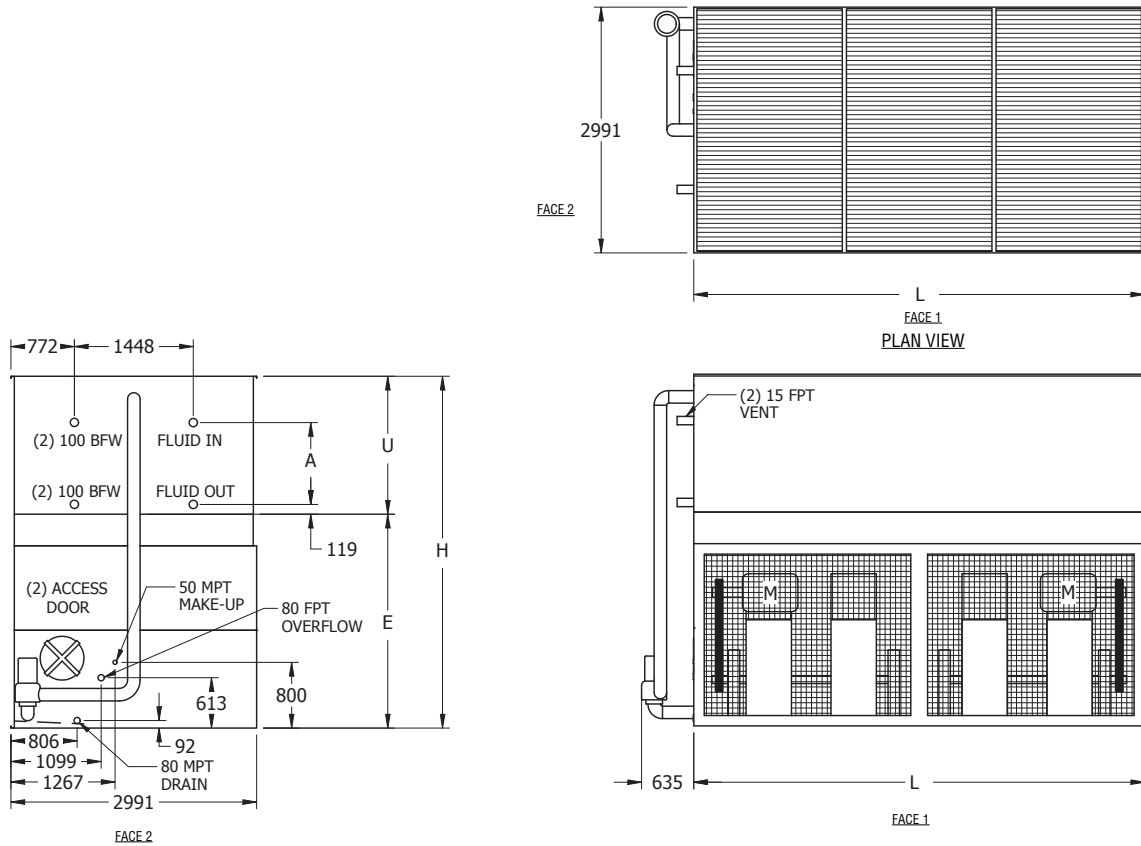

NOTE: The number of coil connections doubles when the flow rate exceeds 56 l/s on 10x18 models. This required option is referred to as the High Flow coil configuration.

Model No. †	Weights (kg)			Fans		Spray Pump		Coil Volume (Liters)	Remote sump Δ			Dimensions ▲				
	Shipping	Heaviest Section*	Operating	kW	m ³ /s	kW	l/s		Liters Req'd**	Conn. Size	Operating Weight (kg)	Height H	Length L	Lower E	Upper U	Coil A
LSWE 10-3K18	8464	5230	12887	(2)15	46.6	5.5	65.0	1417	2271	300	11294	3851	5493	2604	1248	566
LSWE 10-3L18	8491	5230	12914	(2)18.5	50.2	5.5	65.0	1417	2271	300	11322	3851	5493	2604	1248	566
LSWE 10-3M18	8537	5230	12959	(2)22	53.4	5.5	65.0	1417	2271	300	11367	3851	5493	2604	1248	566
LSWE 10-3N18	8682	5230	13104	(2)30	58.8	5.5	65.0	1417	2271	300	11512	3851	5493	2604	1248	566
LSWE 10-4L18	9766	6505	14637	(2)18.5	49.2	5.5	65.0	1868	2271	300	13145	4067	5493	2604	1464	782
LSWE 10-4M18	9811	6505	14683	(2)22	52.3	5.5	65.0	1868	2271	300	13190	4067	5493	2604	1464	782
LSWE 10-4N18	9956	6505	14828	(2)30	57.6	5.5	65.0	1868	2271	300	13336	4067	5493	2604	1464	782
LSWE 10-5L18	10995	7734	16320	(2)18.5	48.3	5.5	65.0	2320	2271	300	14946	4283	5493	2604	1680	997
LSWE 10-5M18	11040	7734	16366	(2)22	51.3	5.5	65.0	2320	2271	300	14991	4283	5493	2604	1680	997
LSWE 10-5N18	11186	7734	16511	(2)30	56.4	5.5	65.0	2320	2271	300	15136	4283	5493	2604	1680	997
LSWE 10-6L18	12274	9013	18048	(2)18.5	47.3	5.5	65.0	2771	2271	300	16787	4499	5493	2604	1895	1213
LSWE 10-6M18	12320	9013	18094	(2)22	50.2	5.5	65.0	2771	2271	300	16833	4499	5493	2604	1895	1213
LSWE 10-6N18	12465	9013	18239	(2)30	55.3	5.5	65.0	2771	2271	300	16978	4499	5493	2604	1895	1213
LSWE 10-7L18	13798	10537	20026	(2)18.5	46.3	5.5	65.0	3222	2271	300	18765	4499	5493	2604	1895	1213
LSWE 10-7M18	13844	10537	20071	(2)22	49.2	5.5	65.0	3222	2271	300	18810	4499	5493	2604	1895	1213
LSWE 10-7N18	13989	10537	20217	(2)30	54.1	5.5	65.0	3222	2271	300	18956	4499	5493	2604	1895	1213

† Model Number will end in "-Z" for units with Series Flow piping configuration. Series Flow units may require additional coil connections and will require crossover piping. Model numbers will include "I" for units with Intake Attenuation, "D" for units with Discharge Attenuation, "F" for units with Full Sound Attenuation, "T" for units with a Tapered Discharge Hood, and "S" for units with an option that negates CTI Certification.

* Heaviest section is the coil section.

** Liters shown is water in suspension in unit and piping. Allow for additional water in bottom of remote sump to cover pump suction and strainer during operation (305 mm would normally be sufficient).

Δ When a remote sump arrangement is selected, the spray pump, suction strainer and associated piping are omitted; the unit is provided with an oversized outlet to facilitate drainage to the remote sump.

▲ Unit dimensions and coil connections may vary slightly from catalog. See factory certified prints for dimensions, quantity of coil connections, and piping configuration. Coil connections are 100 mm bevel for weld (BFW), also available as options. Other connection types such as grooved for mechanical coupling or flanged are also available as options.

Models: LSWE 10-3M24 to 10-7P24

Closed Circuit Coolers

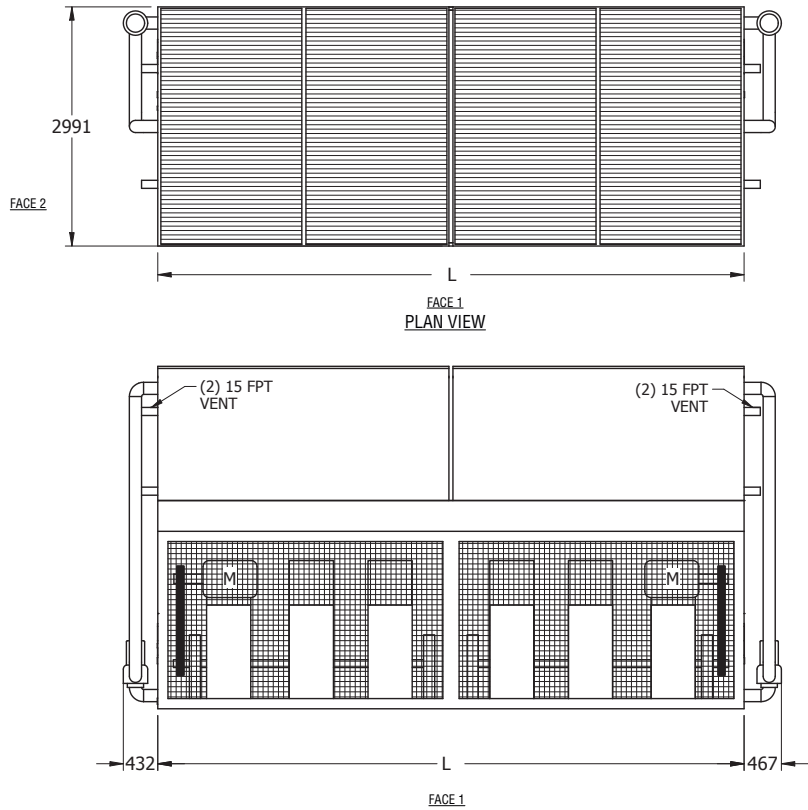

NOTE: The number of coil connections doubles when the flow rate exceeds 113 l/s on 10x24 models. This required option is referred to as the High Flow coil configuration.

Model No. †	Weights (kg)			Fans		Spray Pump		Coil Volume (Liters)	Remote sump Δ			Dimensions ▲				
	Shipping	Heaviest Section*	Operating	kW	m ³ /s	kW	l/s		Liters Req'd**	Conn. Size	Operating Weight (kg)	Height H	Length L	Lower E	Upper U	Coil A
LSWE 10-3M24	11322	4173#	17264	[2] 22	64.5	[2] 4	86.5	1918	3104	[2] 250	15481	3851	7347	2604	1248	566
LSWE 10-3N24	11467	4318#	17409	[2] 30	71.0	[2] 4	86.5	1918	3104	[2] 250	15771	3851	7347	2604	1248	566
LSWE 10-3O24	11476	4327#	17418	[2] 37	76.5	[2] 4	86.5	1918	3104	[2] 250	15790	3851	7347	2604	1248	566
LSWE 10-4M24	13054	4441	19595	[2] 22	63.3	[2] 4	86.5	2515	3104	[2] 250	17962	4067	7347	2604	1464	782
LSWE 10-4N24	13200	4441	19740	[2] 30	69.6	[2] 4	86.5	2515	3104	[2] 250	18253	4067	7347	2604	1464	782
LSWE 10-4O24	13209	4441	19749	[2] 37	75.0	[2] 4	86.5	2515	3104	[2] 250	18271	4067	7347	2604	1464	782
LSWE 10-5M24	14705	5266	21845	[2] 22	62.0	[2] 4	86.5	3113	3104	[2] 250	20357	4283	7347	2604	1680	997
LSWE 10-5N24	14851	5266	21990	[2] 30	68.2	[2] 4	86.5	3113	3104	[2] 250	20648	4283	7347	2604	1680	997
LSWE 10-5O24	14860	5266	21999	[2] 37	73.5	[2] 4	86.5	3113	3104	[2] 250	20666	4283	7347	2604	1680	997
LSWE 10-6M24	16429	6128	24158	[2] 22	60.7	[2] 4	86.5	3711	3104	[2] 250	22820	4499	7347	2604	1895	1213
LSWE 10-6N24	16574	6128	24303	[2] 30	66.8	[2] 4	86.5	3711	3104	[2] 250	23111	4499	7347	2604	1895	1213
LSWE 10-6O24	16583	6128	24313	[2] 37	72.0	[2] 4	86.5	3711	3104	[2] 250	23129	4499	7347	2604	1895	1213
LSWE 10-6P24	16765	6128	24494	[2] 45	76.5	[2] 4	86.5	3711	3104	[2] 250	23492	4499	7347	2604	1895	1213
LSWE 10-7M24	18461	7144	26789	[2] 22	59.5	[2] 4	86.5	4309	3104	[2] 250	25451	4499	7347	2604	1895	1213
LSWE 10-7N24	18606	7144	26934	[2] 30	65.5	[2] 4	86.5	4309	3104	[2] 250	25741	4499	7347	2604	1895	1213
LSWE 10-7O24	18615	7144	26943	[2] 37	70.5	[2] 4	86.5	4309	3104	[2] 250	25759	4499	7347	2604	1895	1213
LSWE 10-7P24	18797	7144	27125	[2] 45	74.9	[2] 4	86.5	4309	3104	[2] 250	26122	4499	7347	2604	1895	1213

† Model Number will end in "-Z" for units with Series Flow piping configuration. Series Flow units may require additional coil connections and will require crossover piping. Model numbers will include "I" for units with Intake Attenuation, "D" for units with Discharge Attenuation, "F" for units with Full Sound Attenuation, "T" for units with a Tapered Discharge Hood, and "S" for units with an option that negates CTI Certification.

* Heaviest section is the coil section.

** Liters shown is water in suspension in unit and piping. Allow for additional water in bottom of remote sump to cover pump suction and strainer during operation (305 mm would normally be sufficient).

Heaviest section is the basin section.

Δ When a remote sump arrangement is selected, the spray pump, suction strainer and associated piping are omitted; the unit is provided with an oversized outlet to facilitate drainage to the remote sump.

▲ Unit dimensions and coil connections may vary slightly from catalog. See factory certified prints for dimensions, quantity of coil connections, and piping configuration. Coil connections are 100 mm bevel for weld (BFW), also available as options. Other connection types such as grooved for mechanical coupling or flanged are also available as options.

Models: LSWE 10-3K36 to 10-7N36

Closed Circuit Coolers

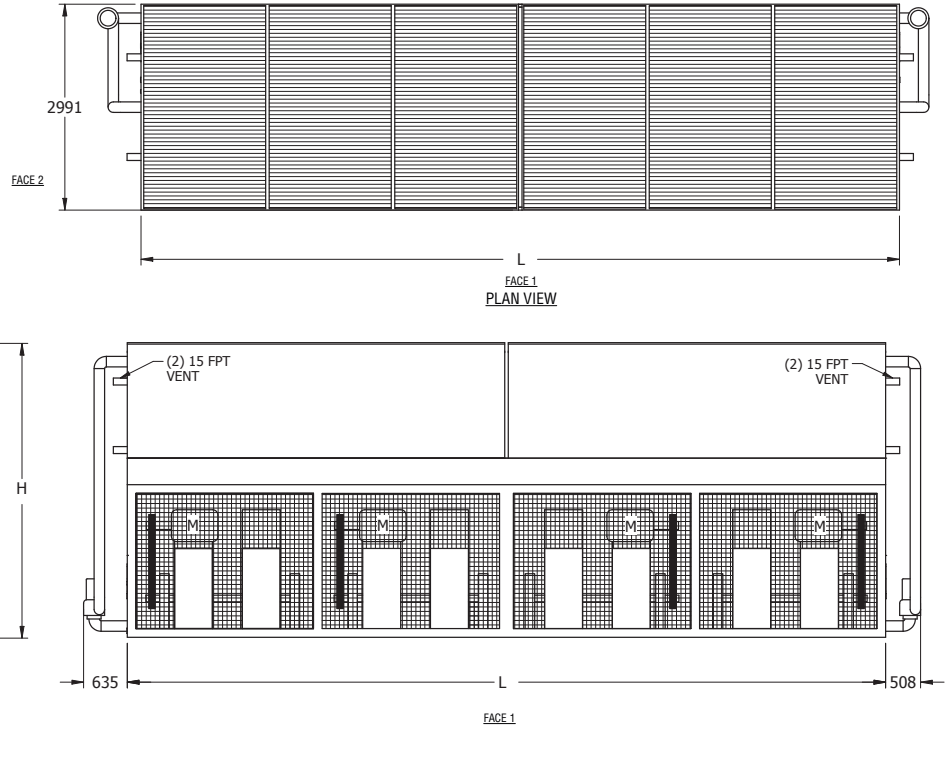

NOTE: The number of coil connections doubles when the flow rate exceeds 113 l/s on 10x36 models. This required option is referred to as the High Flow coil configuration.

Model No. †	Weights (kg)			Fans		Spray Pump		Coil Volume (Liters)	Remote sump Δ			Dimensions ▲				
	Shipping	Heaviest Section*	Operating	kW	m³/s	kW	l/s		Liters Req'd**	Conn. Size	Operating Weight (kg)	Height H	Length L	Lower E	Upper U	Coil A
LSWE 10-3K36	16901	6441††#	25750	(4)15	93.3	(2) 5.5	130.0	2833	5678	(2) 300	23274	3851	11036	2604	1248	566
LSWE 10-3L36	16955	6495††#	25805	(4)18.5	100.5	(2) 5.5	130.0	2833	5678	(2) 300	23383	3851	11036	2604	1248	566
LSWE 10-3M36	17046	6586††#	25896	(4) 22	106.8	(2) 5.5	130.0	2833	5678	(2) 300	23564	3851	11036	2604	1248	566
LSWE 10-3N36	17336	6876††#	26186	(4) 30	117.5	(2) 5.5	130.0	2833	5678	(2) 300	24145	3851	11036	2604	1248	566
LSWE 10-4L36	19504	6505	29252	(4)18.5	98.5	(2) 5.5	130.0	3736	5678	(2) 300	27025	4067	11036	2604	1464	782
LSWE 10-4M36	19595	6586††#	29343	(4) 22	104.7	(2) 5.5	130.0	3736	5678	(2) 300	27206	4067	11036	2604	1464	782
LSWE 10-4N36	19885	6876††#	29633	(4) 30	115.2	(2) 5.5	130.0	3736	5678	(2) 300	27787	4067	11036	2604	1464	782
LSWE 10-5L36	21963	7734	32618	(4)18.5	96.5	(2) 5.5	130.0	4639	5678	(2) 300	30627	4283	11036	2604	1680	997
LSWE 10-5M36	22054	7734	32709	(4) 22	102.6	(2) 5.5	130.0	4639	5678	(2) 300	30808	4283	11036	2604	1680	997
LSWE 10-5N36	22344	7734	32999	(4) 30	112.9	(2) 5.5	130.0	4639	5678	(2) 300	31389	4283	11036	2604	1680	997
LSWE 10-6L36	24512	9008	36065	(4)18.5	94.6	(2) 5.5	130.0	5542	5678	(2) 300	34310	4499	11036	2604	1895	1213
LSWE 10-6M36	24603	9008	36156	(4) 22	100.5	(2) 5.5	130.0	5542	5678	(2) 300	34491	4499	11036	2604	1895	1213
LSWE 10-6N36	24893	9008	36446	(4) 30	110.6	(2) 5.5	130.0	5542	5678	(2) 300	35072	4499	11036	2604	1895	1213
LSWE 10-7L36	27560	10532	40020	(4)18.5	92.6	(2) 5.5	130.0	6445	5678	(2) 300	38265	4499	11036	2604	1895	1213
LSWE 10-7M36	27651	10532	40111	(4) 22	98.4	(2) 5.5	130.0	6445	5678	(2) 300	38446	4499	11036	2604	1895	1213
LSWE 10-7N36	27941	10532	40401	(4) 30	108.3	(2) 5.5	130.0	6445	5678	(2) 300	39027	4499	11036	2604	1895	1213

† Model Number will end in "-Z" for units with Series Flow piping configuration. Series Flow units may require additional coil connections and will require crossover piping. Model numbers will include "I" for units with Intake Attenuation, "D" for units with Discharge Attenuation, "F" for units with Full Sound Attenuation, "T" for units with a Tapered Discharge Hood, and "S" for units with an option that negates C-TI Certification.

†† Model normally ships in one piece.

* Heaviest section is the coil section.

** Liters shown is water in suspension in unit and piping. Allow for additional water in bottom of remote sump to cover pump suction and strainer during operation (305 mm would normally be sufficient).

Heaviest section is the basin section.

Δ When a remote sump arrangement is selected, the spray pump, suction strainer and associated piping are omitted; the unit is provided with an oversized outlet to facilitate drainage to the remote sump.

▲ Unit dimensions and coil connections may vary slightly from catalog. See factory certified prints for dimensions, quantity of coil connections, and piping configuration. Coil connections are 100 mm bevel for weld (BFW), also available as options. Other connection types such as grooved for mechanical coupling or flanged are also available as options.

Models: LRWB 3-2D6 to 3-516

Closed Circuit Coolers

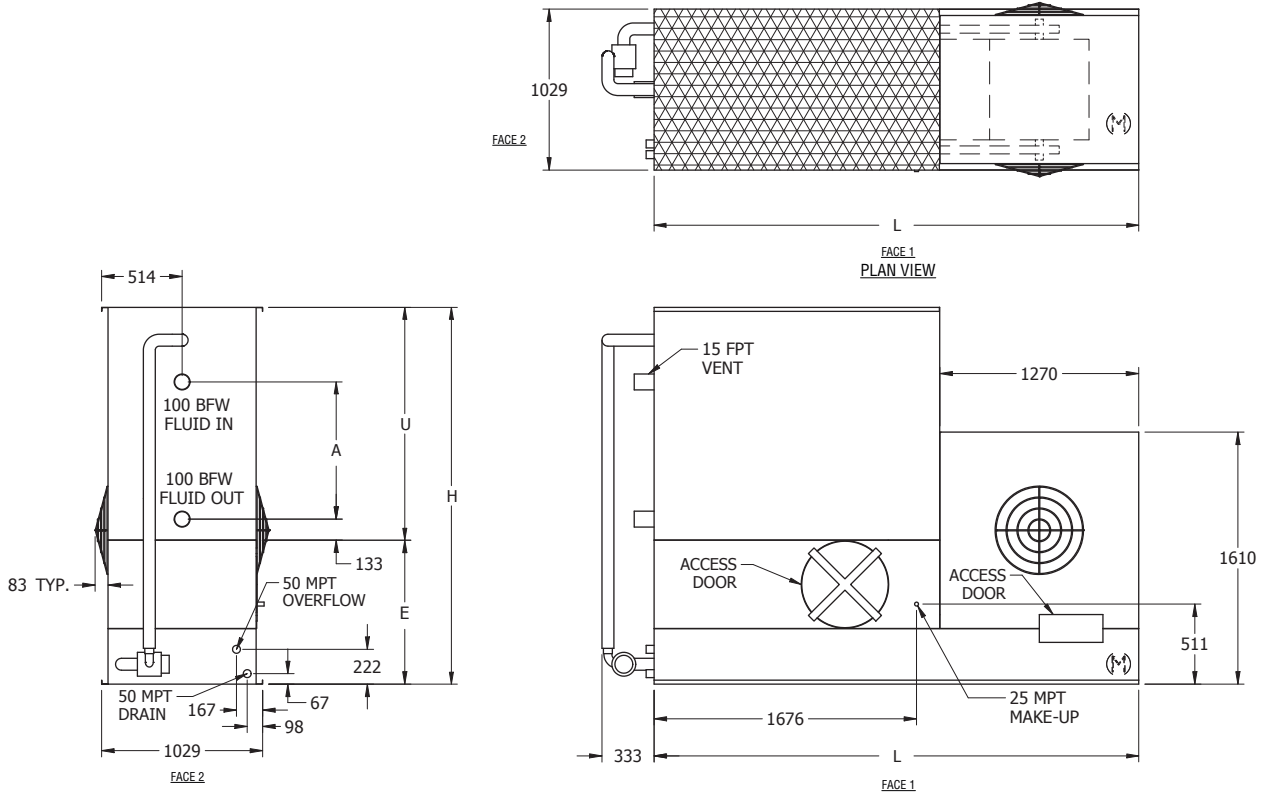

NOTE: The number of coil connections doubles when the flow rate exceeds 28 l/s on 3x6 models. This required option is referred to as the High Flow coil configuration.

Model No. †	Weights (kg)			Fans		Spray Pump		Coil Volume (Liters)	Remote sump Δ			Dimensions ▲				
	Shipping	Heaviest Section *	Operating	kW	m³/s	kW	l/s		Liters Req'd**	Conn. Size	Operating Weight (kg)	Height H	Length L	Lower E	Upper U	Coil A
LRWB 3-2D6	984	984	1542	1.1	3.6	0.37	6.4	115	125	100	1139	1835	3096	921	914	305
LRWB 3-2E6	984	984	1542	1.5	3.9	0.37	6.4	115	125	100	1139	1835	3096	921	914	305
LRWB 3-2F6	998	998	1556	2.2	4.5	0.37	6.4	115	125	100	1152	1835	3096	921	914	305
LRWB 3-2G6	1002	1002	1560	4	5.3	0.37	6.4	115	125	100	1157	1835	3096	921	914	305
LRWB 3-2H6	1025	1025	1583	5.5	6.1	0.37	6.4	115	125	100	1179	1835	3096	921	914	305
LRWB 3-3E6	1116	1116	1719	1.5	3.9	0.37	6.4	162	125	100	1315	2026	3096	921	1105	496
LRWB 3-3F6	1129	1129	1733	2.2	4.4	0.37	6.4	162	125	100	1329	2026	3096	921	1105	496
LRWB 3-3G6	1134	1134	1737	4	5.2	0.37	6.4	162	125	100	1334	2026	3096	921	1105	496
LRWB 3-3H6	1157	1157	1760	5.5	6.0	0.37	6.4	162	125	100	1356	2026	3096	921	1105	496
LRWB 3-4E6	1261	1261	1910	1.5	3.8	0.37	6.4	208	125	100	1506	2216	3096	921	1295	686
LRWB 3-4F6	1275	1275	1923	2.2	4.3	0.37	6.4	208	125	100	1520	2216	3096	921	1295	686
LRWB 3-4G6	1279	1279	1928	4	5.1	0.37	6.4	208	125	100	1524	2216	3096	921	1295	686
LRWB 3-4H6	1302	1302	1950	5.5	5.9	0.37	6.4	208	125	100	1547	2216	3096	921	1295	686
LRWB 3-5F6	1424	1424	2123	2.2	4.3	0.37	6.4	255	125	100	1724	2407	3096	921	1486	877
LRWB 3-5G6	1429	1429	2127	4	5.0	0.37	6.4	255	125	100	1728	2407	3096	921	1486	877
LRWB 3-5H6	1451	1451	2150	5.5	5.8	0.37	6.4	255	125	100	1751	2407	3096	921	1486	877
LRWB 3-5I6	1461	1461	2159	7.5	6.3	0.37	6.4	255	125	100	1760	2407	3096	921	1486	877

† Model Number will end in "-Z" for units with Series Flow piping configuration. Series Flow units may require additional coil connections and will require crossover piping. Model numbers will include "I" for units with Intake Attenuation, "D" for units with Discharge Attenuation, "F" for units with Full Sound Attenuation, "T" for units with a Tapered Discharge Hood, and "S" for units with an option that negates CTI Certification.

* Heaviest section is the coil section.

** Liters shown is water in suspension in unit and piping. Allow for additional water in bottom of remote sump to cover pump suction and strainer during operation (305 mm would normally be sufficient).

Δ When a remote sump arrangement is selected, the spray pump, suction strainer and associated piping are omitted; the unit is provided with an oversized outlet to facilitate drainage to the remote sump.

▲ Unit dimensions and coil connections may vary slightly from catalog. See factory certified prints for dimensions, quantity of coil connections, and piping configuration. Coil connections are 100 mm bevel for weld (BFW), also available as options. Other connection types such as grooved for mechanical coupling or flanged are also available as options.

Models: LRWB 5-2F6 to 5-5I6

Closed Circuit Coolers

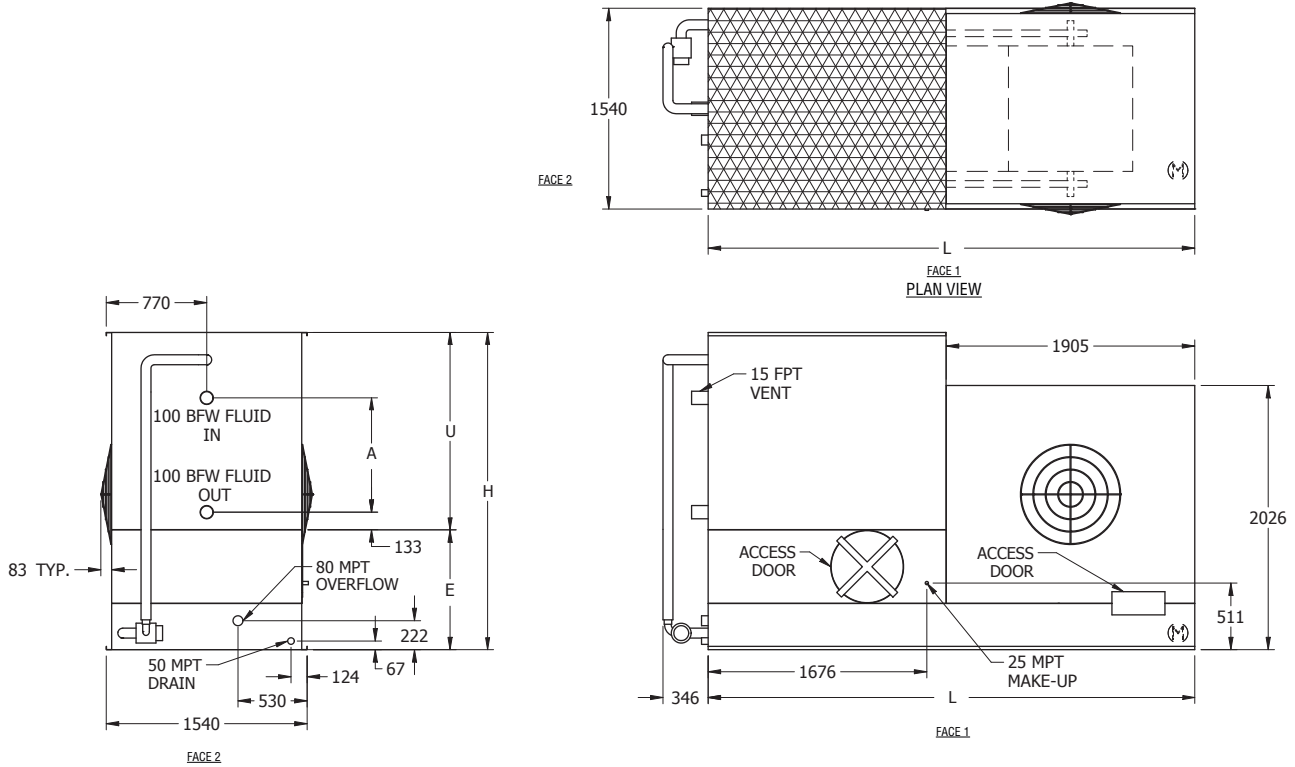

NOTE: The number of coil connections doubles when the flow rate exceeds 28 l/s on 5x6 models. This required option is referred to as the High Flow coil configuration.

Model No. †	Weights (kg)			Fans		Spray Pump		Coil Volume (Liters)	Remote sump Δ			Dimensions ▲				
	Shipping	Heaviest Section*	Operating	kW	m³/s	kW	l/s		Liters Req'd**	Conn. Size	Operating Weight (kg)	Height H	Length L	Lower E	Upper U	Coil A
LRWB 5-2F6	1488	1488	2449	2.2	6.5	0.75	10.1	177	454	150	1760	1835	3731	921	914	305
LRWB 5-2G6	1492	1492	2454	4	7.7	0.75	10.1	177	454	150	1764	1835	3731	921	914	305
LRWB 5-2H6	1515	1515	2477	5.5	8.8	0.75	10.1	177	454	150	1787	1835	3731	921	914	305
LRWB 5-2I6	1524	1524	2486	7.5	9.7	0.75	10.1	177	454	150	1796	1835	3731	921	914	305
LRWB 5-3F6	1692	1692	2726	2.2	6.4	0.75	10.1	251	454	150	2037	2026	3731	921	1105	496
LRWB 5-3G6	1696	1696	2731	4	7.6	0.75	10.1	251	454	150	2041	2026	3731	921	1105	496
LRWB 5-3H6	1719	1719	2753	5.5	8.7	0.75	10.1	251	454	150	2064	2026	3731	921	1105	496
LRWB 5-3I6	1728	1728	2762	7.5	9.5	0.75	10.1	251	454	150	2073	2026	3731	921	1105	496
LRWB 5-4G6	1914	1914	3021	4	7.4	0.75	10.1	324	454	150	2327	2216	3731	921	1295	686
LRWB 5-4H6	1937	1937	3044	5.5	8.5	0.75	10.1	324	454	150	2350	2216	3731	921	1295	686
LRWB 5-4I6	1946	1946	3053	7.5	9.4	0.75	10.1	324	454	150	2359	2216	3731	921	1295	686
LRWB 5-5G6	2145	2145	3325	4	7.3	0.75	10.1	397	454	150	2631	2407	3731	921	1486	877
LRWB 5-5H6	2168	2168	3348	5.5	8.3	0.75	10.1	397	454	150	2654	2407	3731	921	1486	877
LRWB 5-5I6	2177	2177	3357	7.5	9.2	0.75	10.1	397	454	150	2663	2407	3731	921	1486	877

† Model Number will end in "-Z" for units with Series Flow piping configuration. Series Flow units may require additional coil connections and will require crossover piping. Model numbers will include "I" for units with Intake Attenuation, "D" for units with Discharge Attenuation, "F" for units with Full Sound Attenuation, "T" for units with a Tapered Discharge Hood, and "S" for units with an option that negates CTI Certification.

* Heaviest section is the coil section.

** Liters shown is water in suspension in unit and piping. Allow for additional water in bottom of remote sump to cover pump suction and strainer during operation (305 mm would normally be sufficient).

Δ When a remote sump arrangement is selected, the spray pump, suction strainer and associated piping are omitted; the unit is provided with an oversized outlet to facilitate drainage to the remote sump.

▲ Unit dimensions and coil connections may vary slightly from catalog. See factory certified prints for dimensions, quantity of coil connections, and piping configuration. Coil connections are 100 mm bevel for weld (BFW), also available as options. Other connection types such as grooved for mechanical coupling or flanged are also available as options.

Models: LRWB 5-3H9 to 5-6K9

Closed Circuit Coolers

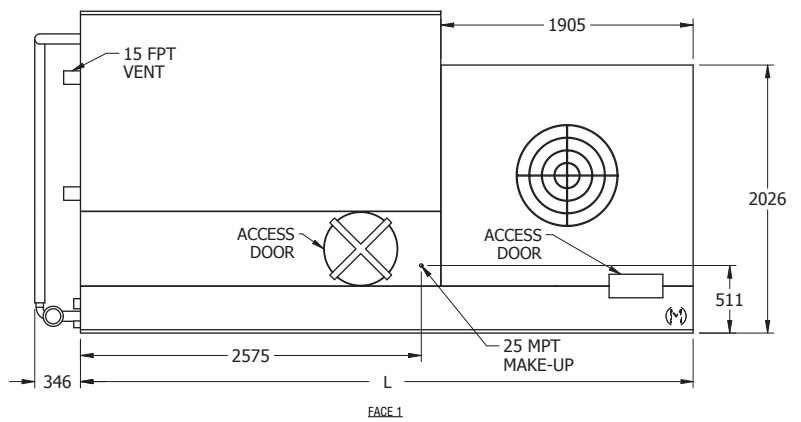
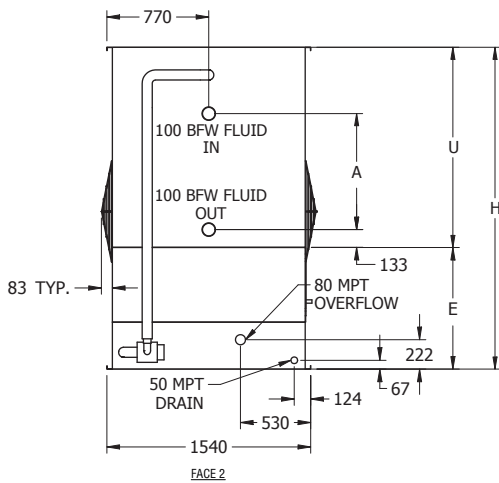
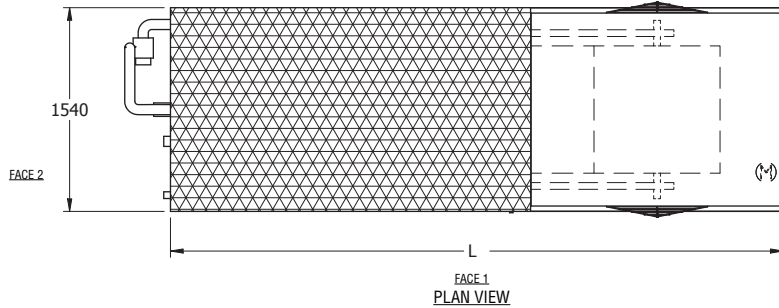

NOTE: The number of coil connections doubles when the flow rate exceeds 28 l/s on 5x9 models. This required option is referred to as the High Flow coil configuration.

Model No. †	Weights (kg)			Fans		Spray Pump		Coil Volume (Liters)	Remote sump Δ			Dimensions ▲				
	Shipping	Heaviest Section *	Operating	kW	m³/s	kW	l/s		Liters Req'd**	Conn. Size	Operating Weight (kg)	Height H	Length L	Lower E	Upper U	Coil A
LRWB 5-3H9	2200	2200	3738	5.5	10.6	1.1	16.1	365	643	150	2740	2026	4629	921	1105	496
LRWB 5-3I9	2209	2209	3747	7.5	11.7	1.1	16.1	365	643	150	2749	2026	4629	921	1105	496
LRWB 5-3J9	2263	2263	3801	11	13.4	1.1	16.1	365	643	150	2803	2026	4629	921	1105	496
LRWB 5-3K9	2291	2291	3828	15	14.7	1.1	16.1	365	643	150	2830	2026	4629	921	1105	496
LRWB 5-4I9	2540	2540	4187	7.5	11.4	1.1	16.1	476	643	150	3189	2216	4629	921	1295	686
LRWB 5-4J9	2595	2595	4241	11	13.1	1.1	16.1	476	643	150	3243	2216	4629	921	1295	686
LRWB 5-4K9	2622	2622	4268	15	14.4	1.1	16.1	476	643	150	3270	2216	4629	921	1295	686
LRWB 5-5I9	2880	2880	4640	7.5	11.2	1.1	16.1	588	643	150	3642	2407	4629	921	1486	877
LRWB 5-5J9	2935	2935	4695	11	12.8	1.1	16.1	588	643	150	3697	2407	4629	921	1486	877
LRWB 5-5K9	2962	2962	4722	15	14.1	1.1	16.1	588	643	150	3724	2407	4629	921	1486	877
LRWB 5-6I9	3171	3171	5039	7.5	11.0	1.1	16.1	699	643	150	4042	2597	4629	921	1676	1067
LRWB 5-6J9	3225	3225	5094	11	12.6	1.1	16.1	699	643	150	4096	2597	4629	921	1676	1067
LRWB 5-6K9	3252	3252	5121	15	13.8	1.1	16.1	699	643	150	4123	2597	4629	921	1676	1067
LRWB 5-7I9	3538	3538	5520	7.5	10.8	1.1	16.1	810	643	150	4522	2743	4629	921	1822	1213
LRWB 5-7J9	3592	3592	5575	11	12.3	1.1	16.1	810	643	150	4577	2743	4629	921	1822	1213
LRWB 5-7K9	3620	3620	5602	15	13.5	1.1	16.1	810	643	150	4604	2743	4629	921	1822	1213

† Model Number will end in "-Z" for units with Series Flow piping configuration. Series Flow units may require additional coil connections and will require crossover piping. Model numbers will include "I" for units with Intake Attenuation, "D" for units with Discharge Attenuation, "F" for units with Full Sound Attenuation, "T" for units with a Tapered Discharge Hood, and "S" for units with an option that negates CTI Certification.

* Heaviest section is the coil section.

** Liters shown in suspension in unit and piping. Allow for additional water in bottom of remote sump to cover pump suction and strainer during operation (305 mm would normally be sufficient).

Δ When a remote sump arrangement is selected, the spray pump, suction strainer and associated piping are omitted; the unit is provided with an oversized outlet to facilitate drainage to the remote sump.

▲ Unit dimensions and coil connections may vary slightly from catalog. See factory certified prints for dimensions, quantity of coil connections, and piping configuration. Coil connections are 100 mm bevel for weld (BFW), also available as options. Other connection types such as grooved for mechanical coupling or flanged are also available as options.

Models: LRWB 5-3J12 to 5-6N12

Closed Circuit Coolers

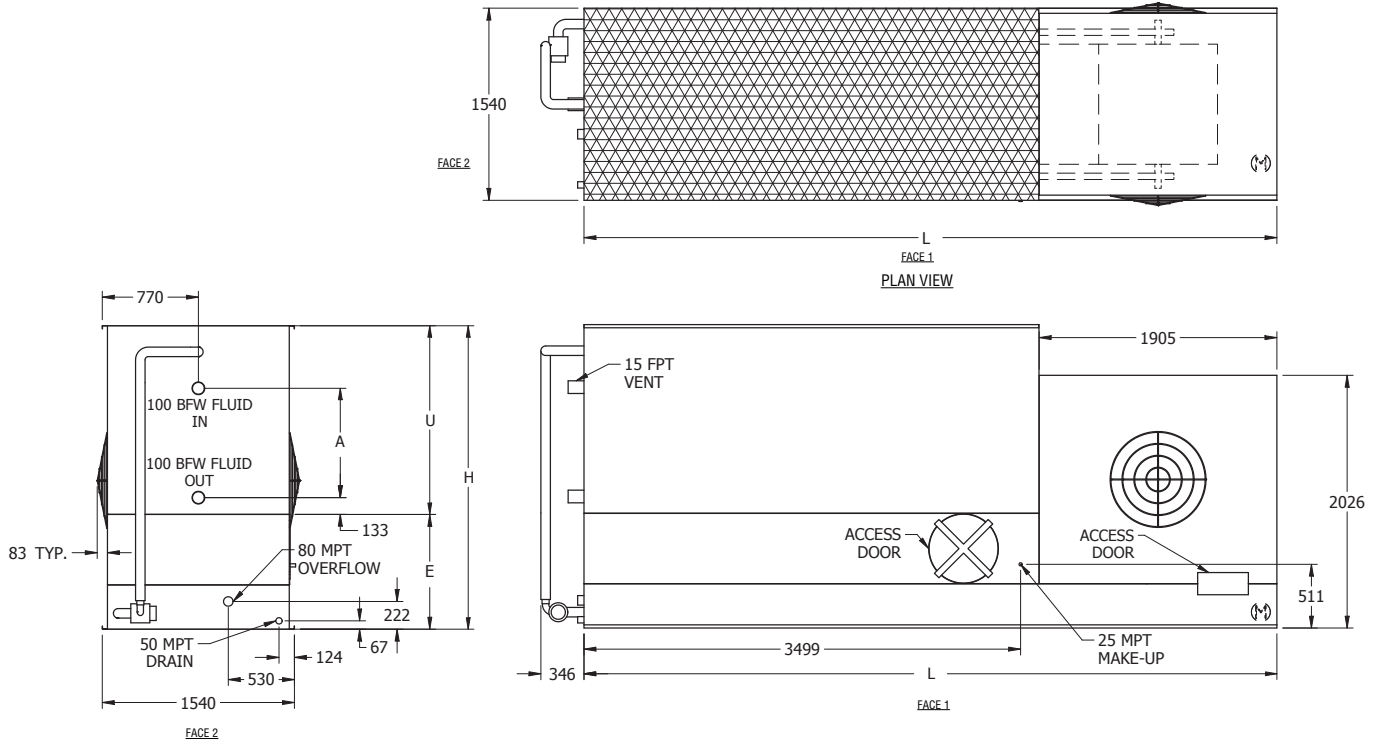

NOTE: The number of coil connections doubles when the flow rate exceeds 28 l/s on 5x12 models. This required option is referred to as the High Flow coil configuration.

Model No. †	Weights (kg)			Fans		Spray Pump		Coil Volume (Liters)	Remote sump Δ			Dimensions ▲				
	Shipping	Heaviest Section*	Operating	kW	m³/s	kW	l/s		Liters Req'd**	Conn. Size	Operating Weight (kg)	Height H	Length L	Lower E	Upper U	Coil A
LRWB 5-3J12	2717	2717	4790	11	15.0	1.5	21.8	479	908	200	3475	2051	5553	921	1130	496
LRWB 5-3K12	2744	2744	4817	15	16.5	1.5	21.8	479	908	200	3502	2051	5553	921	1130	496
LRWB 5-3L12	2758	2758	4831	18.5	17.7	1.5	21.8	479	908	200	3515	2051	5553	921	1130	496
LRWB 5-3M12	2781	2781	4853	22	18.9	1.5	21.8	479	908	200	3538	2051	5553	921	1130	496
LRWB 5-4J12	3157	3157	5380	11	14.7	1.5	21.8	629	908	200	4064	2242	5553	921	1321	686
LRWB 5-4K12	3184	3184	5407	15	16.1	1.5	21.8	629	908	200	4091	2242	5553	921	1321	686
LRWB 5-4L12	3198	3198	5420	18.5	17.4	1.5	21.8	629	908	200	4105	2242	5553	921	1321	686
LRWB 5-4M12	3221	3221	5443	22	18.5	1.5	21.8	629	908	200	4128	2242	5553	921	1321	686
LRWB 5-5K12	3615	3615	5987	15	15.8	1.5	21.8	778	908	200	4672	2432	5553	921	1511	877
LRWB 5-5L12	3629	3629	6001	18.5	17.0	1.5	21.8	778	908	200	4686	2432	5553	921	1511	877
LRWB 5-5M12	3651	3651	6024	22	18.1	1.5	21.8	778	908	200	4708	2432	5553	921	1511	877
LRWB 5-5N12	3724	3724	6096	30	19.9	1.5	21.8	778	908	200	4781	2432	5553	921	1511	877
LRWB 5-6L12	4028	4028	6550	18.5	16.7	1.5	21.8	928	908	200	5234	2623	5553	921	1702	1067
LRWB 5-6M12	4051	4051	6573	22	17.7	1.5	21.8	928	908	200	5257	2623	5553	921	1702	1067
LRWB 5-6N12	4123	4123	6645	30	19.5	1.5	21.8	928	908	200	5330	2623	5553	921	1702	1067
LRWB 5-7L12	4599	4599	7271	18.5	16.4	1.5	21.8	1077	908	200	5951	2769	5553	921	1848	1213
LRWB 5-7M12	4622	4622	7294	22	17.4	1.5	21.8	1077	908	200	5974	2769	5553	921	1848	1213
LRWB 5-7N12	4695	4695	7366	30	19.1	1.5	21.8	1077	908	200	6046	2769	5553	921	1848	1213

† Model Number will end in "-Z" for units with Series Flow piping configuration. Series Flow units may require additional coil connections and will require crossover piping. Model numbers will include "I" for units with Intake Attenuation, "D" for units with Discharge Attenuation, "F" for units with Full Sound Attenuation, "T" for units with a Tapered Discharge Hood, and "S" for units with an option that negates C.T.I. Certification.

* Heaviest section is the coil section.

** Liters shown is water in suspension in unit and piping. Allow for additional water in bottom of remote sump to cover pump suction and strainer during operation (305 mm would normally be sufficient).

Δ When a remote sump arrangement is selected, the spray pump, suction strainer and associated piping are omitted; the unit is provided with an oversized outlet to facilitate drainage to the remote sump.

▲ Unit dimensions and coil connections may vary slightly from catalog. See factory certified prints for dimensions, quantity of coil connections, and piping configuration. Coil connections are 100 mm bevel for weld (BFW), also available as options. Other connection types such as grooved for mechanical coupling or flanged are also available as options.

Models: LRWB 8-3J9 to 8-7O12

Closed Circuit Coolers

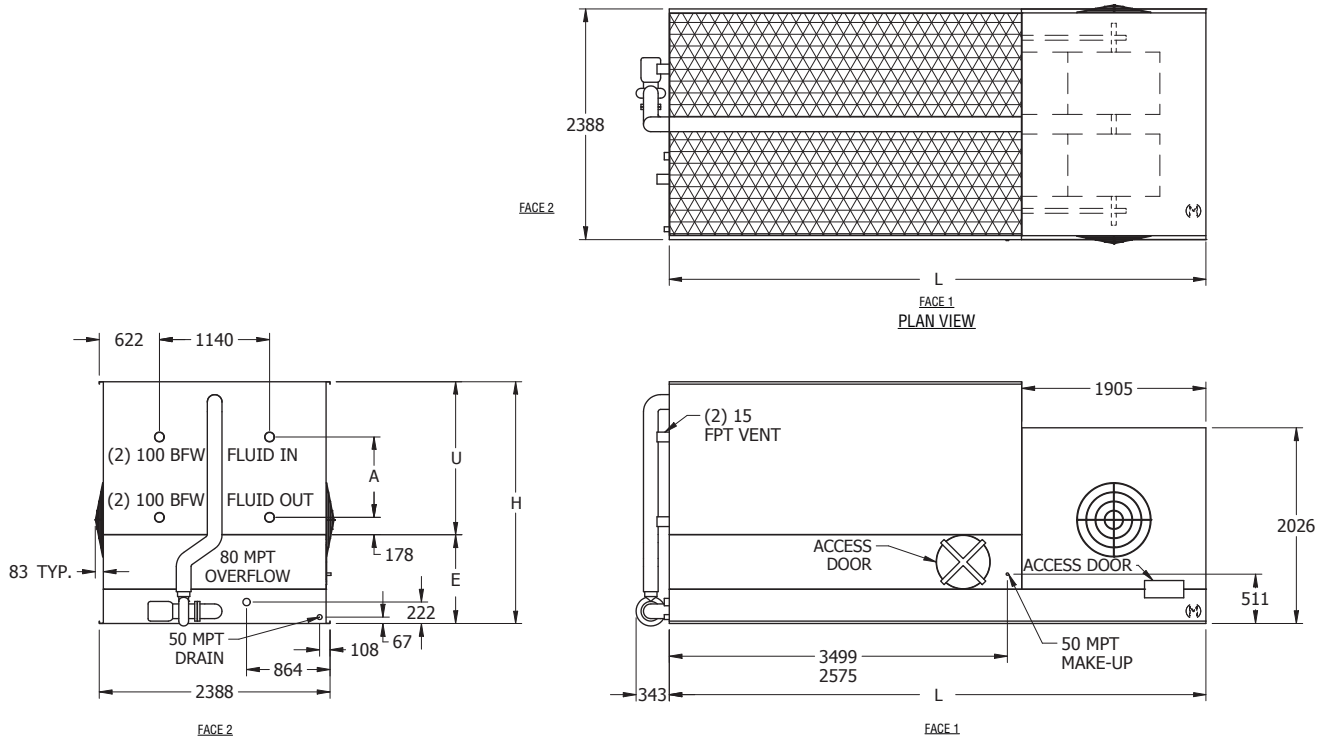

NOTE: The number of coil connections doubles when the flow rate exceeds 56 l/s on 8x9 and 8x12 models. This required option is referred to as the High Flow coil configuration.

Model No. †	Weights (kg)			Fans		Spray Pump		Coil Volume (Liters)	Remote sump Δ			Dimensions ▲				
	Shipping	Heaviest Section*	Operating	kW	m³/s	kW	l/s		Liters Req'd**	Conn. Size	Operating Weight (kg)	Height H	Length L	Lower E	Upper U	Coil A
LRWB 8-3J9	3370	3370	5484	11	17.9	1.5	25.6	576	946	200	4023	2121	4629	921	1200	496
LRWB 8-3K9	3397	3397	5511	15	19.7	1.5	25.6	576	946	200	4051	2121	4629	921	1200	496
LRWB 8-3L9	3411	3411	5525	18.5	21.3	1.5	25.6	576	946	200	4064	2121	4629	921	1200	496
LRWB 8-3M9	3434	3434	5547	22	22.6	1.5	25.6	576	946	200	4087	2121	4629	921	1200	496
LRWB 8-4J9	3860	3860	6151	11	17.6	1.5	25.6	751	946	200	4690	2311	4629	921	1391	686
LRWB 8-4K9	3887	3887	6178	15	19.4	1.5	25.6	751	946	200	4717	2311	4629	921	1391	686
LRWB 8-4L9	3901	3901	6192	18.5	20.8	1.5	25.6	751	946	200	4731	2311	4629	921	1391	686
LRWB 8-4M9	3924	3924	6214	22	22.2	1.5	25.6	751	946	200	4754	2311	4629	921	1391	686
LRWB 8-5K9	4504	4504	6972	15	19.0	1.5	25.6	926	946	200	5511	2502	4629	921	1581	877
LRWB 8-5L9	4518	4518	6985	18.5	20.4	1.5	25.6	926	946	200	5525	2502	4629	921	1581	877
LRWB 8-5M9	4540	4540	7008	22	21.7	1.5	25.6	926	946	200	5547	2502	4629	921	1581	877
LRWB 8-4K12	4654	4654	7770	15	22.6	2.2	34.4	991	1363	250	5806	2311	5553	921	1391	686
LRWB 8-4L12	4667	4667	7784	18.5	24.3	2.2	34.4	991	1363	250	5820	2311	5553	921	1391	686
LRWB 8-4M12	4690	4690	7806	22	25.9	2.2	34.4	991	1363	250	5842	2311	5553	921	1391	686
LRWB 8-4N12	4763	4763	7879	30	28.5	2.2	34.4	991	1363	250	5915	2311	5553	921	1391	686
LRWB 8-4O12	4767	4767	7883	37	30.7	2.2	34.4	991	1363	250	5919	2311	5553	921	1391	686
LRWB 8-5L12	5330	5330	8682	18.5	23.9	2.2	34.4	1227	1363	250	6718	2502	5553	921	1581	877
LRWB 8-5M12	5352	5352	8704	22	25.3	2.2	34.4	1227	1363	250	6740	2502	5553	921	1581	877
LRWB 8-5N12	5425	5425	8777	30	27.9	2.2	34.4	1227	1363	250	6813	2502	5553	921	1581	877
LRWB 8-5O12	5429	5429	8782	37	30.1	2.2	34.4	1227	1363	250	6817	2502	5553	921	1581	877
LRWB 8-6M12	5978	5978	9566	22	24.8	2.2	34.4	1462	1363	250	7602	2692	5553	921	1772	1067
LRWB 8-6N12	6051	6051	9639	30	27.3	2.2	34.4	1462	1363	250	7675	2692	5553	921	1772	1067
LRWB 8-6O12	6055	6055	9643	37	29.4	2.2	34.4	1462	1363	250	7679	2692	5553	921	1772	1067
LRWB 8-7M12	6722	6722	10546	22	24.3	2.2	34.4	1697	1363	250	8582	2838	5553	921	1918	1213
LRWB 8-7N12	6795	6795	10619	30	26.8	2.2	34.4	1697	1363	250	8655	2838	5553	921	1918	1213
LRWB 8-7O12	6799	6799	10623	37	28.8	2.2	34.4	1697	1363	250	8659	2838	5553	921	1918	1213

† Model Number will end in "-Z" for units with Series Flow piping configuration. Series Flow units may require additional coil connections and will require crossover piping. Model numbers will include "I" for units with Intake Attenuation, "D" for units with Discharge Attenuation, "F" for units with Full Sound Attenuation, "T" for units with a Tapered Discharge Hood, and "S" for units with an option that negates CTI Certification.

* Heaviest section is the coil section.

** Liters shown is water in suspension in unit and piping. Allow for additional water in bottom of remote sump to cover pump suction and strainer during operation (305 mm would normally be sufficient).

Δ When a remote sump arrangement is selected, the spray pump, suction strainer and associated piping are omitted; the unit is provided with an oversized outlet to facilitate drainage to the remote sump.

▲ Unit dimensions and coil connections may vary slightly from catalog. See factory certified prints for dimensions, quantity of coil connections, and piping configuration. Coil connections are 100 mm bevel for weld (BFW), also available as options. Other connection types such as grooved for mechanical coupling or flanged are also available as options.



WORLDWIDE MANUFACTURING FACILITIES



- World Headquarters/ Research and Development Center
- EVAPCO Facilities

EVAPCO, Inc. — World Headquarters & Research / Development Center

P.O. Box 1300 • Westminister, MD 21158 USA
410.756.2600 • marketing@evapco.com • evapco.com

North America

EVAPCO, Inc.
World Headquarters
Westminster, MD USA
410.756.2600
marketing@evapco.com

EVAPCO East
Taneytown, MD USA
410.756.2600
marketing@evapco.com

EVAPCO East
Key Building
Taneytown, MD USA
410.756.2600
marketing@evapco.com

EVAPCO Midwest
Greenup, IL USA
217.923.3431
evapcomw@evapcomw.com

EVAPCO West
Madera, CA USA
559.673.2207
contact@evapcowest.com

EVAPCO Iowa
Lake View, IA USA
712.657.3223

EVAPCO Iowa
Sales & Engineering
Medford, MN USA
507.446.8005
evapcomn@evapcomn.com

EVAPCO Newton
Newton, IL USA
618.783.3433
evapcomw@evapcomw.com

Evapcold Manufacturing
Greenup, IL USA
217.923.3431
evapcomw@evapcomw.com

EVAPCO Dry Cooling, Inc.
Bridgewater, NJ USA
908.379.2665
info@evapcodc.com

EVAPCO Dry Cooling, Inc.
Littleton, CO USA
908.379.2665
info@evapcodc.com
Spare Parts: 908.895.3236
Spare Parts: spares@evapcodc.com

EVAPCO Power México S. de R.L. de C.V.
Mexico City, Mexico
(52) 55.8421.9260
info@evapcodc.com

Refrigeration Vessels & Systems Corporation
A wholly owned subsidiary of EVAPCO, Inc.
Bryan, TX USA
979.778.0095
rvs@rvscorp.com

EvapTech, Inc.
A wholly owned subsidiary of EVAPCO, Inc.
Edwardsville, KS USA
913.322.5165
marketing@evaptech.com

Tower Components, Inc.
A wholly owned subsidiary of EVAPCO, Inc.
Ramseur, NC USA
336.824.2102
mail@towercomponentsinc.com

EVAPCO Alcoil, Inc.
A wholly owned subsidiary of EVAPCO, Inc.
York, PA USA
717.347.7500
info@evapco-alcoil.com

Europe

EVAPCO Europe
EMENA Headquarters
Tongeren, Belgium
(32) 12.39.50.29
evapco.europe@evapco.be

EVAPCO Europe BVBA
Tongeren, Belgium
(32) 12.39.50.29
evapco.europe@evapco.be

EVAPCO Europe, S.r.l.
Milan, Italy
(39) 02.939.9041
evapcoeuropa@evapco.it

EVAPCO Europe, S.r.l.
Sondrio, Italy

EVAPCO Europe GmbH
Meerbusch, Germany
(49) 2159.69560
info@evapco.de

EVAPCO Europe A/S
Aabybro, Denmark
(45) 9824.4999
info@evapco.dk

Evap Egypt Engineering Industries Co.
A licensed manufacturer of EVAPCO, Inc.
Nasr City, Cairo, Egypt
(20) 10 05432198
mmanz@tiba-group.com /
hany@tiba-group.com

EVAPCO Middle East DMCC
Dubai, United Arab Emirates
(971) 56.991.6584
info@evapco.ae

EVAPCO S.A. (Pty.) Ltd.
A licensed manufacturer of EVAPCO, Inc.
Isando, South Africa
(27) 11.392.6630
evapco@evapco.co.za

Asia Pacific

EVAPCO Asia Pacific
Headquarters
Baoshan Industrial Zone
Shanghai, P.R. China
(86) 21.6687.7786
marketing@evapcochina.com

EVAPCO (Shanghai) Refrigeration Equip. Co., Ltd.
Baoshan Industrial Zone, Shanghai, P.R. China
(86) 21.6687.7786
marketing@evapcochina.com

EVAPCO (Beijing) Refrigeration Equip. Co., Ltd.
Huairou District, Beijing, P.R. China
(86) 10.6166.7238
marketing@evapcochina.com

EVAPCO Air Cooling Systems (Jiaxing) Comp., Ltd.
Jiaxing, Zhejiang, China
(86) 573.8311.9379
info@evapcochina.com

EVAPCO Australia (Pty.) Ltd.
Riverstone, NSW, Australia
(61) 02.9627.3322
sales@evapco.com.au

EvapTech Asia Pacific Sdn. Bhd
A wholly owned subsidiary of EvapTech, Inc.
Puchong, Selangor, Malaysia
(60) 3.8070.7255
marketing-ap@evaptech.com

South America

EVAPCO Brasil
Equipamentos Industriais Ltda.
Indaiatuba, São Paulo, Brazil
(55) 11.5681.2000
vendas@evapco.com.br

FanTR Technology Resources
Itu, São Paulo, Brazil
(55) 11.4025.1670
fantr@fantr.com

