



LSCCE

EVAPORATIVE CONDENSERS



CROSSCOOL™
Technology

LOW SOUND

FORCED DRAFT, COUNTERFLOW EVAPORATIVE CONDENSERS

Thermal Performance from 155 to 6931 kW Nominal Capacity

RESEARCH POWERED SOLUTIONS!

CERTIFIED EN ISO 9001



LSCE



Since its founding in 1976, EVAPCO, Inc. has become a world-wide leader in supplying quality cooling equipment for thousands of customers in both the commercial and industrial markets.

EVAPCO's success has been the result of a continual commitment to product improvement, quality workmanship and a dedication to providing unparalleled service.



Our emphasis on research and development has led to many product innovations – a hallmark of EVAPCO through the years.

The ongoing R & D Program enables EVAPCO to provide the most advanced products in the industry – technology for the future, available today.

EVAPCO products are manufactured on five continents around the world and distributed through hundreds of factory authorized sales representatives.

The LSCE units are a result of EVAPCO's extensive experience in forced draft centrifugal fan designs and are designed for easy maintenance and long, **trouble free operation**. These units are also designed with IBC Compliant construction. All features shown are available on all models.

Z-725 Heavy Mill Galvanized Steel Construction

(Stainless steel available as an affordable option)

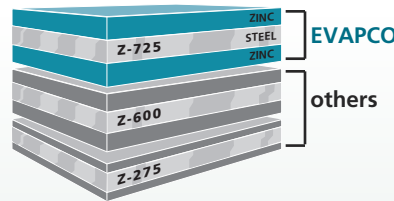

Easy Field Assembly

- Ensures easy assembly and fewer fasteners.
- Incorporates self-guiding channels to guide the casing section into position
- Improved quality of the field seam



Stainless Steel Strainer

- Resists corrosion better than other materials

Clean Pan Design

- Sloped design allows water to drain completely from cold water basin.
- Easier removal of dirt and debris.

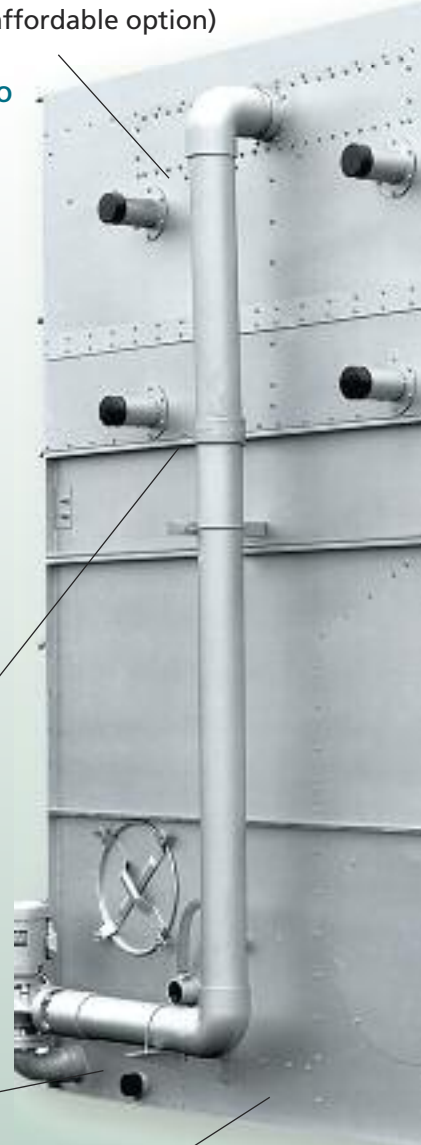

DESIGN AND CONSTRUCTION FEATURES



IBC Compliant Design
 Refer to page 13 for details



Fully Integrated Water Saver Drift Eliminators

- New patented design reduces drift rate to < 0.001%
- Saves water and reduces water treatment cost
- Greater structural integrity vs. old style blade-type
- Eliminators now integrated within casing section for easy mounting of ductwork, discharge hood and attenuation
- Drift rate certifications Eurovent OM-14-2009



PVC Spray Distribution Header

- Nozzles are threaded into the header.
- Fixed position nozzles require little maintenance.
- Large orifice nozzle with integral sludge ring to prevent clogging.

Thermal Pak® II Heat Transfer Technology

- Features EVAPCO's exclusive **CROSScool™** tube enhancement for greater internal heat transfer.
- More surface area per plan area than competitive designs.
- Improved heat transfer efficiency due to tube geometry and orientation of tubes.
- Lower refrigerant charge.
- Optional Stainless Steel Coil technology.

NEW



Totally Enclosed Fan Motors & Superior Drive System

- Assures long life
- Located in dry, incoming air-stream, allowing normal maintenance to be done from the outside of the unit
- If required, motor can be easily removed
- One piece fan shaft
- Belt tensioning and bearing lubrication can be performed from outside the unit
- Motor is fully accessible by removing one inlet screen

LSCE

DESIGN FEATURES

EVAPCOAT:

Z-725 Hot-Dip Galvanized Steel Construction

The Z-725 Mill Hot-Dip Galvanized Steel Construction is the heaviest level of galvanizing available for manufacturing evaporative condensers and has more zinc protection than competitive designs using Z-275 and Z-600 steel.

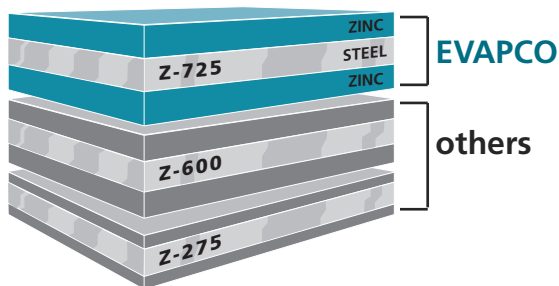

EVAPCO has been a leader in the industry in developing heavier galvanizing, and was the first to standardize on Z-725 mill hot-dip galvanized steel. Z-725 designation means there is a minimum of 725 g/m² total zinc present on the steel.

During fabrication, all panel edges are coated with a 95% pure zinc-rich compound for extended corrosion resistance.

The EVAPCOAT Corrosion Protection System is the heaviest galvanized coating available for extended corrosion protection eliminating the need for costly, unreliable epoxy paint finishes.

Stainless Steel Material Options

The EVAPCO Corrosion Protection System is satisfactory for most applications. If additional corrosion protection is required the following stainless steel options are available (AISI 304 and 316). Please contact your local EVAPCO representative for pricing.

- Stainless Steel Cold Water Basin
- Stainless Steel Water Touch Basin
- Stainless Steel Water Touch Unit
- All Stainless Steel Unit

Thermal-Pak® II Coil

EVAPCO'S Thermal-Pak® II condensing coils are designed for maximum heat transfer efficiency. This unique coil design utilizes counterflow heat transfer. The rows of elliptical tubes are staggered and angled in the direction of airflow to enhance air turbulence, thereby increasing heat transfer while minimizing airside pressure drop.

The design features of EVAPCO'S Thermal-Pak® II condensing coils ensure the end user will receive the best evaporative heat transfer efficiency.

These characteristics and other engineering advancements of the Thermal-Pak® II have been proven in EVAPCO'S world-class research and development laboratory resulting in the following end user benefits:

- Lower Operating Refrigerant Charge
- Low Power Consumption Per Ton
- Lower Operating Weight
- Small Plan Area Per Ton

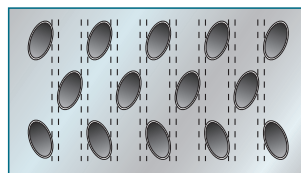

Thermal-Pak® II Coil by EVAPCO

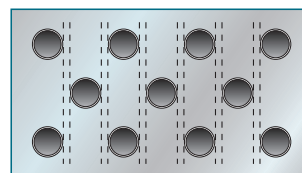

Round Tube Coil by Others

The coils are manufactured from high quality internally enhanced **CROSSCOOL™** carbon steel tubing following the most stringent quality control procedures. Each circuit is inspected to assure the material quality and then tested before being assembled into a coil.

Finally, the assembled coil is tested in accordance with the "Pressure Equipment Directive" (PED) 97/23/EC.

To protect the coil against corrosion, it is placed in a heavy-duty steel frame and the entire assembly is dipped in molten zinc (hot dip galvanized) at a temperature of approximately 430°C.



Thermal-Pak® Coil

LSCE

DESIGN FEATURES

Capacity Control

All LSCE models come standard with efficient, inverter-ready fan motors that can be used with variable frequency drive (VFD) systems for precise capacity control. VFD systems can control the speed of a fan motor by modulating the voltage and frequency of the motor input electrical signal. When connected to a building automation system a VFD can receive signals varying fan speeds to meet demand loads. This popular method of capacity control can yield significant energy savings.

Evapco offers two-speed fan motors as an option for alternative capacity control. In periods of lightened loads or reduced wet bulb temperatures the fans can operate at low speed providing about 60% of full speed capacity yet consuming only about 15% of full speed power. These motors do not require the use of VFD systems however they can only operate at two speeds: full or low.

Basin Access

The basin/fan section of a centrifugal fan unit is designed for accessibility and ease of maintenance.

Large circular access doors are provided to allow entry into the basin. All float valve and strainer assemblies are located near the door for easy adjustment and cleaning. The sump is designed to catch the dirt accumulated. This can be flushed out simply with a hose. The stainless steel strainers may be easily removed for periodic cleaning.



Efficient Drift Eliminators

An extremely efficient drift eliminator system is standard on the LSCE Condenser. The system removes entrained water droplets from the air stream to limit the drift rate to less than 0.001% of the recirculating water rate. With a low drift rate, the LSCE Condenser saves valuable water and water treatment chemicals. The LSCE can be located in areas where minimum water carry-over is critical, such as parking lots.

The drift eliminators are constructed of an inert polyvinyl chloride (PVC) plastic material which effectively eliminates corrosion of these vital components. They are assembled in sections to

facilitate easy removal for inspection of the water distribution system. EVAPCO can provide the Eurovent drift rate certificate in accordance with OM-14-2009.

In addition to reducing drift, the eliminators protect the spray system from debris and prevent sunlight from entering the condenser.

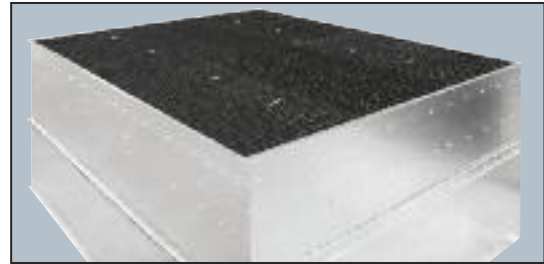

LSCE Drift Eliminators



Drift Eliminators Removed for Coil Inspection

Stainless Steel Strainers

One other component of evaporative cooling equipment which is subject to excessive wear is the suction strainer. **EVAPCO provides a Type 304 stainless steel strainer on all units as standard** (except remote sump applications). Strainers are positioned around a large anti-vortex hood in easily handled sections.

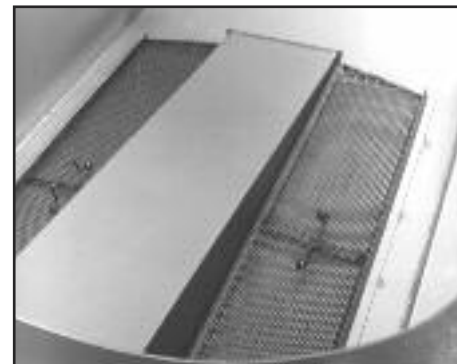

Strainer

*U.S. Patent No. 4,500,330

LSCE

DESIGN FEATURES

Low Installed Costs

The LSCE forced draft condenser is designed using a modular concept to minimize rigging, piping and support costs. All major components are factory assembled into complete sections. Fans, shafts, bearings and drives are installed and aligned at the factory as an integral part of the pan section to eliminate the necessity of field rigging these key parts.

Fan Motors

All LSCE models utilize heavy duty totally enclosed fan motors (T.E.F.C.) designed specifically for condenser applications. In addition, EVAPCO offers many optional motors to meet your specific needs.

Fan Motor Location

EVAPCO mounts the fan motor in a convenient open area to make it easy to adjust belt tension, access the motor, electrically connect it, or change the motor if necessary. The fan motor and drive are under a protective cover for safety purposes and to protect them from the elements.

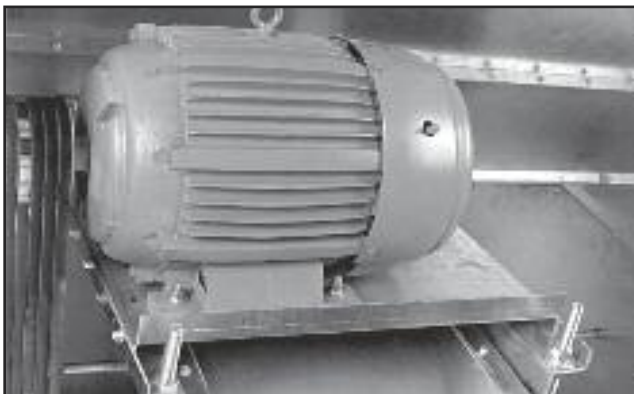

Large Series Motor Mount

Centrifugal Fan Assembly

Fans on the LSCE models are of the forward curved centrifugal type with hot-dip galvanized steel construction. All fans are statically and dynamically balanced and mounted in a hot-dip galvanized steel housing designed and manufactured by EVAPCO.



Centrifugal wheel

LSCE

OPTIONAL EQUIPMENT

Pan Freeze Protection

Remote Sump

Whenever a condenser is idle during sub-freezing weather, the water in the sump must be protected from freezing and damaging the pan. The simplest and most reliable method of accomplishing this is with a remote sump tank located in a heated space in the building under the condenser. With this system, the water in the condenser drains to the indoor tank whenever the pump is shut-off. When a condenser is ordered for remote sump operation, the standard float valve and strainer are omitted, and the unit is provided with an oversized water outlet connection. When a remote sump is not possible, a supplementary means of heating the pan water must be provided.

Electric Heaters

Electric immersion heaters are available factory installed in the basin of the tower. They are sized to maintain a +4°C to +5°C pan water temperature at -18°C ambient with the fans off. They are furnished with a combination thermostat/low water protection device to cycle the heater on when required and to prevent the heater elements from energizing unless they are completely submerged. All components are enclosed in rugged, weather proof enclosures for outdoor use. Heater control packages are available as an option.

Contact your EVAPCO representative for further details.

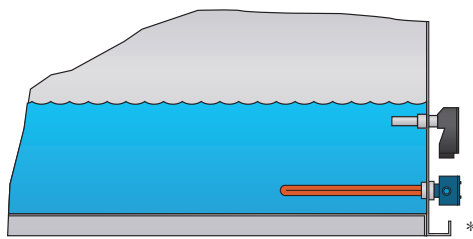

Basin Heater

*See factory certified prints for detailed drawings.

Unit No.	KW*	Unit No.	KW*
LSCE 36 to 80	1 x 2 kW	LSCE 281 to 386	1 x 5 kW
LSCE 90 to 120	1 x 3 kW	LSCE 410 to 560	2 x 4 kW
LSCE 135 to 170	1 x 3 kW	LSCE 591 to 770	2 x 5 kW
		LSCE 820 to 1120	2 x 7 kW
LSCE 185 to 250	1 x 4 kW	LSCE 400 to 515	1 x 7 kW
LSCE 280 to 385	2 x 3 kW	LSCE 550 to 805	2 x 5 kW
		LSCE 800 to 1030	2 x 7 kW
		LSCE 1100 to 1610	2 x 10 kW

* Electric heater selection based on -18°C ambient temperature. For alternate low ambient heater selections, consult the factory.

Electric Water Level Control

EVAPCO LSCE Condensers are available with an optional electric water level control system in place of the standard mechanical makeup valve and float assembly. This package provides accurate control of the pan water level and does not require field adjustment, even under widely variable operating conditions.

The control was designed by EVAPCO and consists of multiple heavy duty stainless steel electrodes. These electrodes are mounted external to the unit in a vertical stand pipe. For winter operation, the stand pipe must be wrapped with electric heating cable and insulated to protect it from freezing. The weather protected slow closing solenoid valve for the makeup water connection is factory supplied and is ready for piping to a water supply with a pressure between 140 kPa (minimum) and 700 kPa (maximum).

Vibration Isolators

The fans on EVAPCO condensers are balanced and run virtually vibration free. In addition, the rotating mass is very small in relation to the total mass of the condenser, further reducing the possibility of objectionable vibration being transmitted to the building structure. As a result, vibration isolation is generally not required.

Other Options Available:

- Pump Heater
- Pony Motors
- Tapered Discharge Hoods
- Solid Bottom Panels
- Dual Pump Assembly

LSCE

APPLICATIONS

Principle of Operation

The refrigerant gas is discharged from the compressor into the inlet connection of the evaporative condenser. Water from the condenser's sump is continuously distributed over the condenser coil, while ambient air is simultaneously forced into the unit. As the ambient air moves up through the coil section, a portion of the spray water is evaporated into the air stream. The evaporative process cools the spray water, which in turn cools the tubes containing the refrigerant gas. The cool tube walls cause the refrigerant gas to give up heat and condense into a liquid. The condensed liquid flows out of the coil's sloping tubes to the high pressure liquid receiver for return to the system. The hot saturated air is driven through the drift eliminators, where any entrained water droplets are removed. The condenser's fan then discharges this air stream out of the top of the unit at a high velocity, where it can dissipate harmlessly into the atmosphere. The water which was not evaporated falls into the sump and is recirculated by the spray pump to the water distribution system above the condensing coil section.

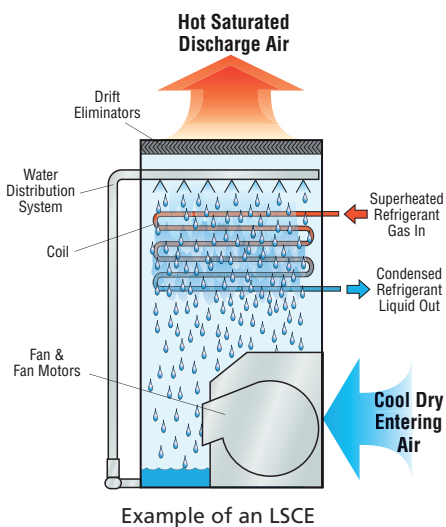

Application Versatility

Centrifugal fan units are recommended for a wide range of installations. They are excellent for larger installations where very quiet operation is a must, such as residential neighborhoods.

In addition, centrifugal fan units can operate against the static pressure loss of ductwork and are ideal for indoor installations.



LSCE unit

Very Quiet Operation

Centrifugal fan units provide an inherently low noise characteristic which makes this design preferred for most installations that require low sound levels. The sound they produce is predominantly in the high frequencies which is easily attenuated by building walls, windows, and natural barriers. Additionally, since the sound from the fans is directional, single sided air entry models can be turned away from critical areas avoiding a sound problem. When even quieter operation is necessary, centrifugal fan models can be equipped with optional sound attenuation packages. See the Sound Reducing Options section of this catalog or consult the factory for details.

Indoor Installation

Centrifugal condensers can be installed indoors when it is desirable to hide the unit or when it is the only space available. In addition to being quiet, they can handle the external static pressure of ductwork by using the next larger size fan motor. Drawings are available showing how to make ductwork connections.

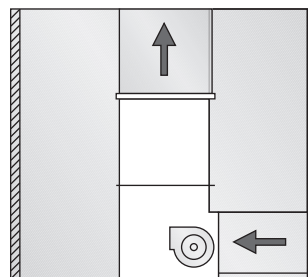

Blow-Thru Construction

All moving parts of Forced Draft Condenser fans, motors, bearing, drives, and belts, are in the the dry entering air stream. This design feature reduces corrosion and maintenance problems in these vital areas.

APPLICATIONS

APPLICATIONS

LSCE

EVAPCO LSCE Condensers have heavy-duty construction and are designed for long, trouble-free operation. However, proper equipment selection, installation and maintenance are necessary to insure good unit performance. Some of the major considerations in the application of a condenser are presented below. For additional information, please contact the factory.

Air Circulation

In reviewing the system design and unit location, it is important that enough fresh air is provided to enable proper unit performance. The best location is on an unobstructed roof top or on ground level away from walls and other barriers. Care must be taken when locating condensers in wells or enclosures or next to high walls. The potential for recirculation of the hot, moist discharge air back into the fan intake exists. Recirculation raises the wet bulb temperature of the entering air causing the condensing temperature to rise above design. For these cases, a discharge hood or ductwork should be provided to raise the overall unit height even with the adjacent wall, thereby reducing the chance of recirculation. For additional information see the EVAPCO Equipment Layout Manual. Engineering assistance is also available from the factory to identify potential recirculation problems and recommend solutions.

Maintaining the Recirculated Water System

The heat rejection in a condenser is accomplished by the evaporation of a portion of the recirculated spray water. As this water evaporates, it leaves behind all of its mineral content and impurities. Therefore, it is important to bleed-off an amount of water equal to that which is evaporated to prevent the buildup of impurities. If this is not done, the mineral content and/or the corrosive nature of the water will continue to increase. This will ultimately result in heavy scaling or a corrosive condition.

Bleed-off

A bleed line should be installed in the piping, external to the unit. The bleed line must be properly sized for the application and provided with a metering connection and globe valve. If the make-up water supplying the unit is relatively free of impurities, it may be possible to cut back the bleed, but the unit must be checked frequently to make sure scale is not forming. Make-up water pressure must be maintained between 140 and 350 kPa for proper operation of the float valve.

Water Treatment

In some cases the make-up water will be so high in mineral content that a normal bleed-off will not prevent scaling. In this case, water treatment will be required. If chemical water treatment is utilized, contact reputable water treatment company familiar with the local water conditions. Any chemical water treatment used must be compatible with the stainless or galvanized construction of the unit. The pH of the water should be maintained between 7 and 8.8. In order to prevent "white rust", the galvanized steel in the unit may require routine passivation of the steel when operating in higher pH levels. Batch chemical feeding is not recommended because it does not afford the proper degree of control.

If acid cleaning is required, extreme caution must be exercised and only inhibited acids compatible with galvanized steel construction should be used.

Control of Biological Contamination

Water quality should be checked regularly for biological contamination. If biological contamination is detected, a more aggressive water treatment and mechanical cleaning program should be undertaken. The water treatment program should be performed by a qualified water treatment company and in accordance with relevant local legislation. It is important that all internal surfaces be kept clean of accumulated dirt and sludge. In addition, the drift eliminators should be maintained in good operating condition.

Note: The location of the condenser must be considered during the equipment layout stages of a project. It is important to prevent the discharge air (potential of biological contamination) from being introduced into the fresh air intakes of the building.

LSCE

APPLICATIONS

Piping

Evaporative condensers are used in refrigeration systems as an efficient means of heat rejection. Their installation and specifically the installation of the piping to and from the evaporative condenser has a direct effect on their operation and the overall energy efficiency of the refrigeration system. In this manual, we will explore the principles of piping evaporative condensers, beginning with single condensers and exploring multiple condenser installations as well as thermosiphon and sub-cooling piping systems.

Background

Evaporative condensers came into common use for nearly all refrigeration systems because of their operating advantages over the combination of cooling towers and condensers. They, of course, have also replaced the old "once through" water cooled condensing systems which are obsolete today because of the restrictions on the unlimited use of water coupled with its high cost.

Although, shell and tube condensing systems performed the same job of condensing the hot discharge gas into a saturated liquid as evaporative condensers; a small difference in the operating characteristics, namely pressure drop, requires some modification in the refrigerant piping hookup to and from the evaporative condenser. These changes are particularly important when dealing with multiple unit installations. In order to understand why the piping hookup is important, let's first take a brief look at the basic design differences of the two types of condensers to see why there is a difference in the pressure drop characteristics.

The shell type refrigerant condensers allow the refrigerant to flow around and condense on the outside of the water tubes (see Figure 1).

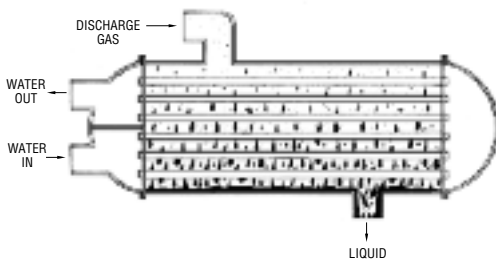

Figure 1

The refrigerant flow is almost entirely unimpeded resulting in a very low or nearly zero pressure drop through the condenser.

TYPICAL EVAPORATIVE CONDENSER COIL

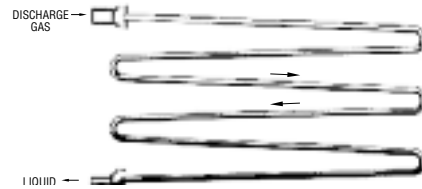
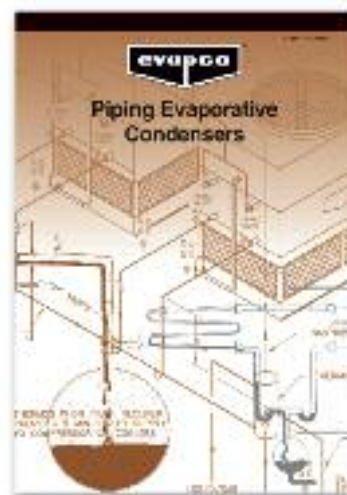

Figure 2

Contrasting, most evaporative condensers (see Figure 2) utilize some type of serpentine coil design where the hot refrigerant gas enters the top of the coil traveling back and forth through several rows as it is cooled and changed from a hot superheated gas to a saturated liquid. This longer travel path generally produces a small pressure drop which, though insignificant to the overall operation of the refrigeration system, does require proper attention be given to the condenser piping. Most of this attention needs to be focused on the liquid drain line from the outlet of the evaporative condenser to the high pressure receiver. The reason for this is described in the "Piping Brochure".

Piping Brochure

For additional information refer to EVAPCO Bulletin 131-E "Piping Evaporative Condensers" or consult your nearest Representative.



APPLICATIONS

LSCE



The LSCE Condenser is now available with sound attenuators to reduce the overall sound generated from the side or top of the Condenser.

Each option provides various levels of sound reduction and can be used in combination to provide the lowest sound level.



Condenser Attenuation

LSCE

DISCHARGE & INTAKE ATTENUATION DIMENSIONS

Sound Attenuation

The centrifugal fan design of the LSCE models operate at lower sound levels which make the units preferable for installations where noise is a concern. For extremely noise sensitive installations, the LSCE models may be supplied with inlet and/or discharge attenuation packages which greatly reduce the sound levels.

Discharge attenuation quiets sound radiating from the top of the unit and features a design with insulated walls acoustically lined with high density fiberglass.

Inlet attenuation reduces sound radiated through the condenser air intakes and consists of acoustically lined baffles to capture radiated noise.

LSCE Discharge Attenuation Dimensions*

Box size	H1 (mm)	L1 (mm)	W1 (mm)	Weight (kg)	Number of attenuat.
4x6	1190	1830	1160	190	1
4x9	1190	2730	1160	255	1
4x12	1190	3640	1160	335	1
4x18	1190	5490	1160	465	1
5x12	1190	3640	1570	405	1
5x18	1190	5490	1570	555	1
8x12	1810	3640	2420	550	1
8x18	1810	5490	2420	745	1
8x24	1810	3640	2420	550	2
8x36	1810	5490	2420	1110	2
3mx12	1810	3640	3020	650	1
3mx18	1810	5490	3020	875	1
3mx24	1810	3640	3020	960	2
3mx36	1810	5490	3020	1335	2

LSCE Intake Attenuation Dimensions*

Box size	H2 (mm)	L2 (mm)	W2 (mm)	Width 1142 mm Compact (kg)	Width 1410 mm Basic (kg)	Width 1810 mm Extended (kg)	Number of attenuat.
4x6	1010	1830	1160	275	345	445	1
4x9	1010	2730	1160	395	485	610	1
4x12	1010	3640	1160	510	615	775	1
4x18	1010	5490	1160	795	935	1145	1
5x12	1171	3640	1570	625	710	840	1
5x18	1171	5490	1570	965	1075	1235	1
8x12	2070	3640	2420	825	965	1175	1
8x18	2070	5490	2420	1255	1440	1715	1
8x24	2070	3640	2420	825	960	1160	2
8x36	2070	5490	2420	1270	1440	1695	2
3mx12	2246	3640	3020	915	1055	1260	1
3mx18	2246	5490	3020	1245	1485	1835	1
3mx24	2246	3640	3020	920	1050	1245	2
3mx36	2246	5490	3020	1425	1585	1820	2

*Attenuation dimensions may vary slightly from catalog. See factory certified prints for exact dimensions.

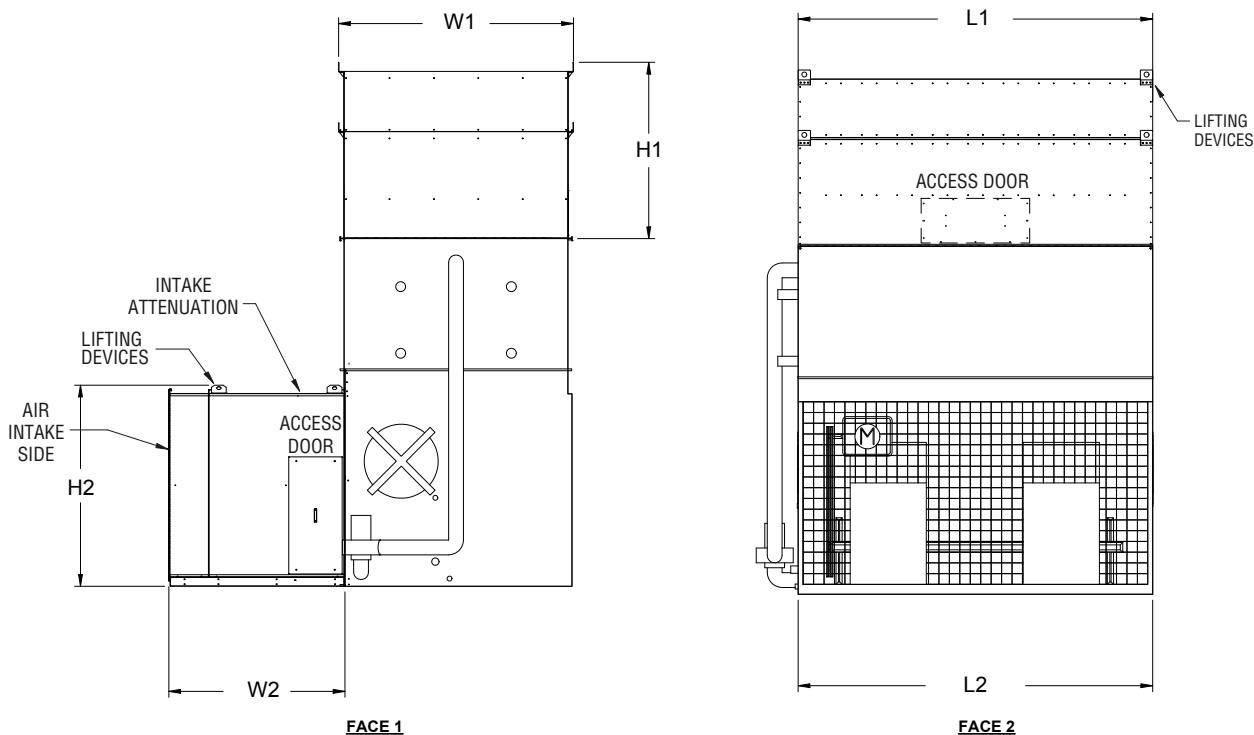

LSCE Attenuation

SOUND

LSCE

We Stand Tall Through it All!



The International Building Code (IBC) is a comprehensive set of regulations addressing the structural design and installation requirements for building systems – including HVAC and industrial refrigeration equipment.

With the advent of the IBC, EVAPCO is proud to introduce the LSCE Condensers with IBC 2012 compliance standard.



Wind, Rain, Earthquake and Hurricane

EVAPCO Condensers... designed to withstand seismic or wind load forces.

LSCE

IBC COMPLIANCE

In its continuing commitment to be the leaders in evaporative cooling equipment design and services, EVAPCO LSCE Condensers are now **Independently Certified** to withstand Seismic and Wind Loads in accordance with IBC 2012.

What is IBC?

International Building Code

The International Building Code (IBC) is a comprehensive set of regulations addressing both the structural design and the installation requirements for building systems – including HVAC and industrial refrigeration equipment.

Compared to previous building codes that considered only the building structure and component anchorage, the requirements contained within the IBC address anchorage, structural integrity, and the operational capability of a component following either a seismic or wind load event. **Simply stated, the IBC code provisions require that evaporative cooling equipment, and all other components permanently installed on a structure, must be designed to meet the same seismic or wind load forces as the building to which they are attached.**

How Does IBC 2012 Apply to Condensers?

Based on site design factors, calculations are made to determine the equivalent seismic “g force” and wind load (kilo-Newton per square meter, kN/m²) on the unit. The evaporative condenser must be designed to withstand the greater of either the seismic or wind load.

The New LSCE is offered with a choice of TWO structural design packages:

- **Standard Structural Design** – For projects with ≤1.0g seismic or 6,94 kN/m² wind loads
- **Upgraded Structural Design** – Required for projects with >1.0 g seismic or 6,94 kN/m² wind loads

All locations with design criteria resulting in a seismic design force of up to 1.0 g or a wind load of 6,94 kN/m² or below will be provided with the standard LSCE structural design. An upgraded structural design is available for installations with design criteria resulting in “g forces” greater than 1.0g. The highest “g force” location in North America is 5.12 g. The highest wind load shown on the maps is 273 km/h, which is approximately equal to 6,94 kN/m² velocity pressure. **Therefore, the upgraded structural design package option for the New LSCE is designed for 5.12 g and 6,94 kN/m² making it applicable to ALL building locations in North America.**

Design Implementation

EVAPCO applies the seismic design and wind load information provided for the project to determine the equipment design necessary to meet IBC requirements. This process ensures that the mechanical equipment and its components are compliant per the provisions of the IBC as given in the plans and specifications for the project.

Independent Certification

Although the IBC references and is based on the structural building code ASCE 7, many chapters and paragraphs of ASCE 7 are superseded by the IBC, independent certification and methods of analysis are such paragraphs. Per the most recent edition of the code, the EVAPCO compliance process included an exhaustive analysis by an independent approval agency. As required by the International Building Code, EVAPCO supplies a certificate of compliance as part of its submittal documents. The certificate of compliance demonstrates that the equipment has been independently tested and analyzed in accordance with the IBC seismic and wind load requirements. Evapco has worked closely with the independent approval agency, The VMC Group, to complete the independent equipment testing and analysis.

For further questions regarding IBC compliance, please contact your local EVAPCO Representative.



LSCE

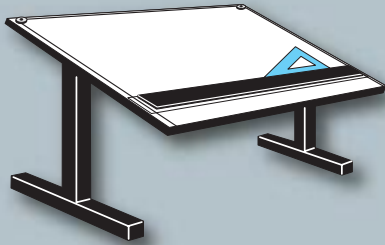

Engineering Data & Dimensions

LSCE

ENGINEERING DATA AND DIMENSIONS

Models LSCE 36 to 170

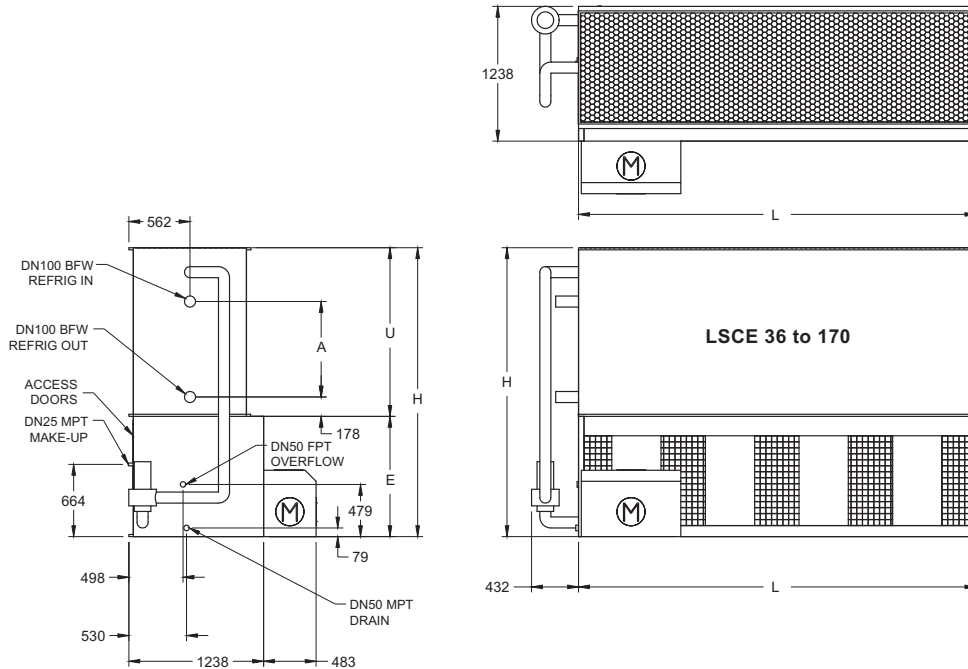

Model No.	Fans		Weights (kg)			Refrigerant Operating Charge (kg)	Coil Volume (l)	Spray Pump kW	Remote Pump			Dimensions (mm)				
	kW	m ³ /s	Shipping	Operating	Heaviest Section*				Liters Req'd**	Conn. Size (mm)	Operating Weight	Height H	Length L	Lower E	Upper U	Coil A
LSCE 36	2,2	4,8	1070	1395	605	15	126	0,55	305	100	1205	2083	1826	1105	978	305
LSCE 41	4	5,8	1075	1400	610	15	126	0,55	305	100	1210	2083	1826	1105	978	305
LSCE 48	2,2	4,8	1235	1570	765	21	177	0,55	305	100	1375	2273	1826	1105	1168	495
LSCE 54	4	5,6	1240	1575	770	21	177	0,55	305	100	1380	2273	1826	1105	1168	495
LSCE 65	4	5,5	1395	1745	930	27	229	0,55	305	100	1550	2464	1826	1105	1359	686
LSCE 70	5,5	6,3	1420	1770	955	27	229	0,55	305	100	1575	2464	1826	1105	1359	686
LSCE 75	4	5,4	1560	1920	1095	33	280	0,55	305	100	1730	2654	1826	1105	1549	876
LSCE 80	5,5	6,2	1585	1940	1115	33	280	0,55	305	100	1750	2654	1826	1105	1549	876
LSCE 90	4	7,2	1930	2470	1305	39	336	0,75	455	150	2220	2464	2724	1105	1359	686
LSCE 100	5,5	8,2	1955	2490	1330	39	336	0,75	455	150	2240	2464	2724	1105	1359	686
LSCE 110	7,5	9,1	1965	2500	1340	39	336	0,75	455	150	2250	2464	2724	1105	1359	686
LSCE 120	7,5	8,9	2205	2760	1580	49	414	0,75	455	150	2505	2654	2724	1105	1549	876
LSCE 135	7,5	11	2575	3255	1755	52	443	1,1	645	150	2980	2464	3651	1105	1359	686
LSCE 150	11	12,6	2630	3310	1810	52	443	1,1	645	150	3035	2464	3651	1105	1359	686
LSCE 155	7,5	10,8	2870	3575	2050	64	548	1,1	645	150	3310	2654	3651	1105	1549	876
LSCE 170	11	12,3	2925	3630	2105	64	548	1,1	645	150	3365	2654	3651	1105	1549	876

* Heaviest section is the coil section

** Liters shown is water in suspension in unit and piping. Allow for additional water in bottom of remote sump to cover pump suction and strainer during operation. (300 mm would normally be sufficient.)

Refrigerant charge is shown for R-717. Multiply by 1.93 for R22, 1.98 for R134A and 1.7 for R404A, R410A and R507A.

Dimensions are subject to change. Do not use for pre-fabrication.

ENGINEERING DATA AND DIMENSIONS



Models LSCE 185 to 385

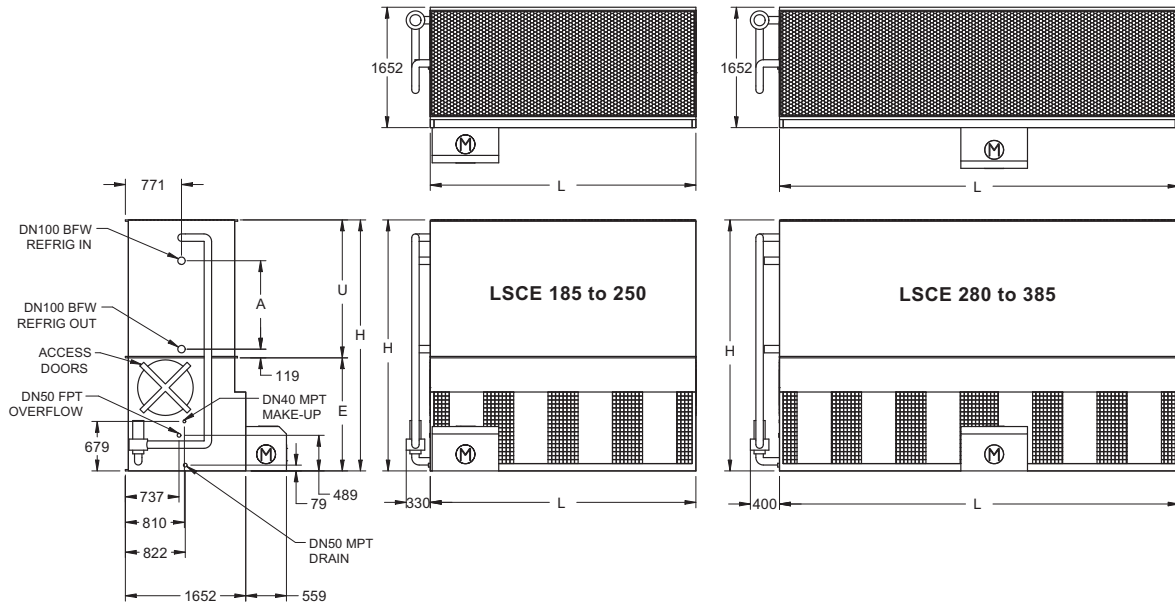

Model No.	Fans		Weights (kg)			Refrigerant Operating Charge (kg)	Coil Volume (l)	Spray Pump kW	Remote Pump			Dimensions (mm)				
	kW	m ³ /s	Shipping	Operating	Heaviest Section*				Liters Req'd**	Conn. Size (mm)	Operating Weight	Height H	Length L	Lower E	Upper U	Coil A
LSCE 185	7,5	13,8	3400	4645	2320	74	629	1,5	870	150	3880	3013	3645	1553	1461	781
LSCE 200	11	15,9	3455	4700	2370	74	629	1,5	870	150	3935	3013	3645	1553	1461	781
LSCE 210	15	17,5	3485	4725	2400	74	629	1,5	870	150	3960	3013	3645	1553	1461	781
LSCE 225	11	15,5	3910	5185	2825	92	778	1,5	870	150	4425	3229	3645	1553	1676	997
LSCE 240	15	17,1	3935	5210	2855	92	778	1,5	870	150	4450	3229	3645	1553	1676	997
LSCE 250	15	16,8	4380	5695	3300	109	928	1,5	870	150	4935	3445	3645	1553	1892	1213
LSCE 280	11	20,8	5110	6875	3490	110	934	2,2	1285	200	5525	3013	5483	1553	1461	781
LSCE 300	15	22,9	5140	6905	3515	110	934	2,2	1285	200	5550	3013	5483	1553	1461	781
LSCE 315	18,5	24,7	5155	6915	3530	110	934	2,2	1285	200	5565	3013	5483	1553	1461	781
LSCE 335	15	22,5	5825	7640	4200	136	1160	2,2	1285	200	6295	3229	5483	1553	1676	997
LSCE 355	18,5	24,2	5840	7650	4215	136	1160	2,2	1285	200	6310	3229	5483	1553	1676	997
LSCE 370	22	25,7	5860	7675	4235	136	1160	2,2	1285	200	6330	3229	5483	1553	1676	997
LSCE 385	22	25,2	6525	8390	4905	163	1386	2,2	1285	200	7060	3445	5483	1553	1892	1213

* Heaviest section is the coil section

** Liters shown is water in suspension in unit and piping. Allow for additional water in bottom of remote sump to cover pump suction and strainer during operation. (300 mm would normally be sufficient.)

Refrigerant charge is shown for R-717. Multiply by 1.93 for R22, 1.98 for R134A and 1.7 for R404A, R410A and R507A.

Dimensions are subject to change. Do not use for pre-fabrication.

LSCE

ENGINEERING DATA AND DIMENSIONS

Models LSCE 281 to 560

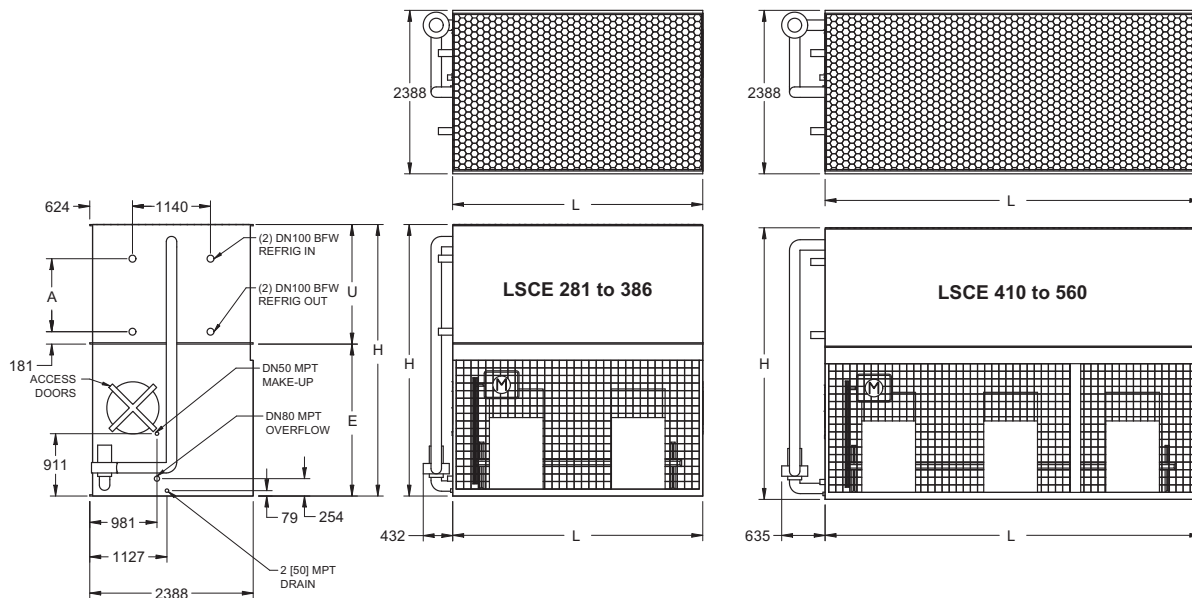

Model No.	Fans		Weights (kg)			Refrigerant Operating Charge (kg)	Coil Volume (l)	Spray Pump kW	Remote Pump			Dimensions (mm)				
	kW	m ³ /s	Shipping	Operating	Heaviest Section*				Liters Req'd**	Conn. Size (mm)	Operating Weight	Height H	Length L	Lower E	Upper U	Coil A
LSCE 281	15	22,5	5045	6800	3490	117	991	4	1365	250	5955	3585	3651	2219	1365	686
LSCE 295	18,5	24,2	5060	6815	3500	117	991	4	1365	250	5970	3585	3651	2219	1365	686
LSCE 310	22	25,8	5080	6835	3525	117	991	4	1365	250	5990	3585	3651	2219	1365	686
LSCE 330	18,5	23,7	5695	7505	4140	144	1227	4	1365	250	6715	3775	3651	2219	1556	876
LSCE 345	22	25,2	5720	7530	4165	144	1227	4	1365	250	6735	3775	3651	2219	1556	876
LSCE 360	22	24,7	6380	8240	4825	172	1462	4	1365	250	7500	3966	3651	2219	1746	1067
LSCE 386	30	27,2	6455	8315	4900	172	1462	4	1365	250	7575	3966	3651	2219	1746	1067
LSCE 410	18,5	31,7	7295	9955	5115	173	1472	5,5	2005	300	8725	3585	5486	2219	1365	686
LSCE 431	22	33,7	7315	9980	5140	173	1472	5,5	2005	300	8745	3585	5486	2219	1365	686
LSCE 460	30	37	7390	10050	5210	173	1472	5,5	2005	300	8820	3585	5486	2219	1365	686
LSCE 475	22	33	8265	11010	6085	215	1827	5,5	2005	300	9850	3775	5486	2219	1556	876
LSCE 490	37	39,9	7395	10055	5215	173	1472	5,5	2005	300	8820	3585	5486	2219	1365	686
LSCE 510	30	36,3	8335	11080	6160	215	1827	5,5	2005	300	9925	3775	5486	2219	1556	876
LSCE 530	30	35,6	9345	12165	7165	257	2183	5,5	2005	300	11080	3966	5486	2219	1746	1067
LSCE 540	37	39,2	8340	11085	6165	215	1827	5,5	2005	300	9930	3775	5486	2219	1556	876
LSCE 560	37	38,3	9350	12170	7170	257	2183	5,5	2005	300	11085	3966	5486	2219	1746	1067

* Heaviest section is the coil section

** Liters shown is water in suspension in unit and piping. Allow for additional water in bottom of remote sump to cover pump suction and strainer during operation. (300 mm would normally be sufficient.)

Refrigerant charge is shown for R-717. Multiply by 1.93 for R22, 1.98 for R134A and 1.7 for R404A, R410A and R507A.

Dimensions are subject to change. Do not use for pre-fabrication.

ENGINEERING DATA AND DIMENSIONS



Models LSCE 591 to 770

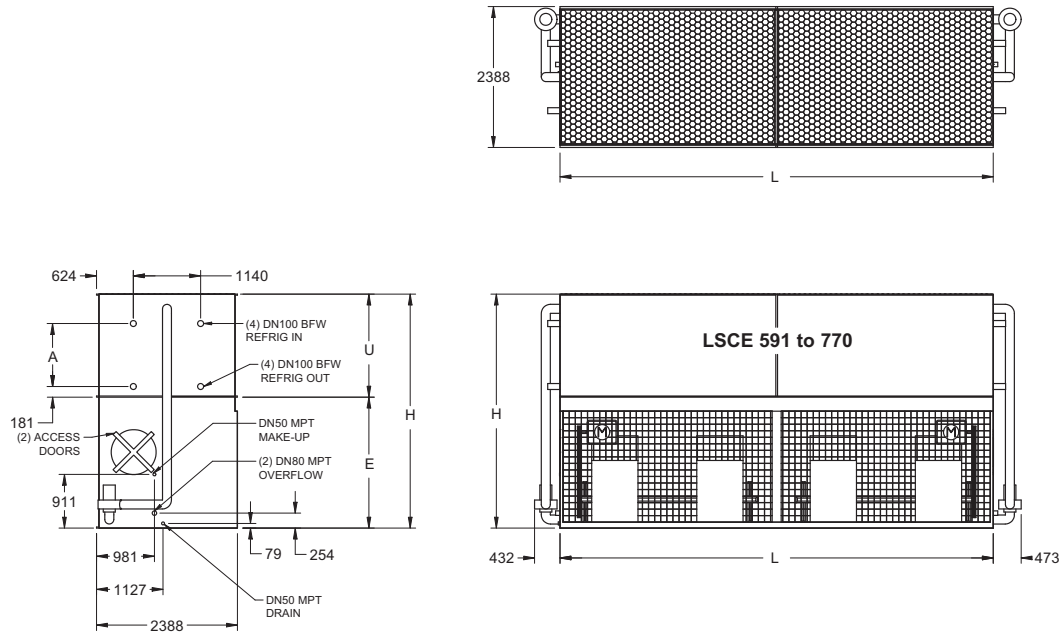

Model No.	Fans		Weights (kg)			Refrigerant Operating Charge (kg)	Coil Volume (l)	Spray Pump kW	Remote Pump			Dimensions (mm)				
	kW	m ³ /s	Shipping	Operating	Heaviest Section*				Liters Req'd**	Conn. Size (mm)	Operating Weight	Height H	Length L	Lower E	Upper U	Coil A
LSCE 591	(2) 18.5	48,5	10150	13695	3675	233	1983	(2) 4	2725	(2) 250	12060	3585	7341	2219	1365	686
LSCE 620	(2) 22	51,5	10240	13785	3720	233	1983	(2) 4	2725	(2) 250	12150	3585	7341	2219	1365	686
LSCE 660	(2) 18.5	47,5	11440	15090	4320	288	2453	(2) 4	2725	(2) 250	13555	3775	7341	2219	1556	876
LSCE 691	(2) 22	50,5	11530	15180	4365	288	2453	(2) 4	2725	(2) 250	13645	3775	7341	2219	1556	876
LSCE 721	(2) 22	49,5	12855	16605	5025	344	2924	(2) 4	2725	(2) 250	15180	3966	7341	2219	1746	1067
LSCE 770	(2) 30	54,4	13145	16895	5170	344	2924	(2) 4	2725	(2) 250	15470	3966	7341	2219	1746	1067

* Heaviest section is the coil section
 ** Liters shown is water in suspension in unit and piping. Allow for additional water in bottom of remote sump to cover pump suction and strainer during operation. (300 mm would normally be sufficient.)
 Refrigerant charge is shown for R-717. Multiply by 1.93 for R22, 1.98 for R134A and 1.7 for R404A, R410A and R507A.
 Dimensions are subject to change. Do not use for pre-fabrication.

LSCE

ENGINEERING DATA AND DIMENSIONS

Models LSCE 820 to 1120

ENGINEERING

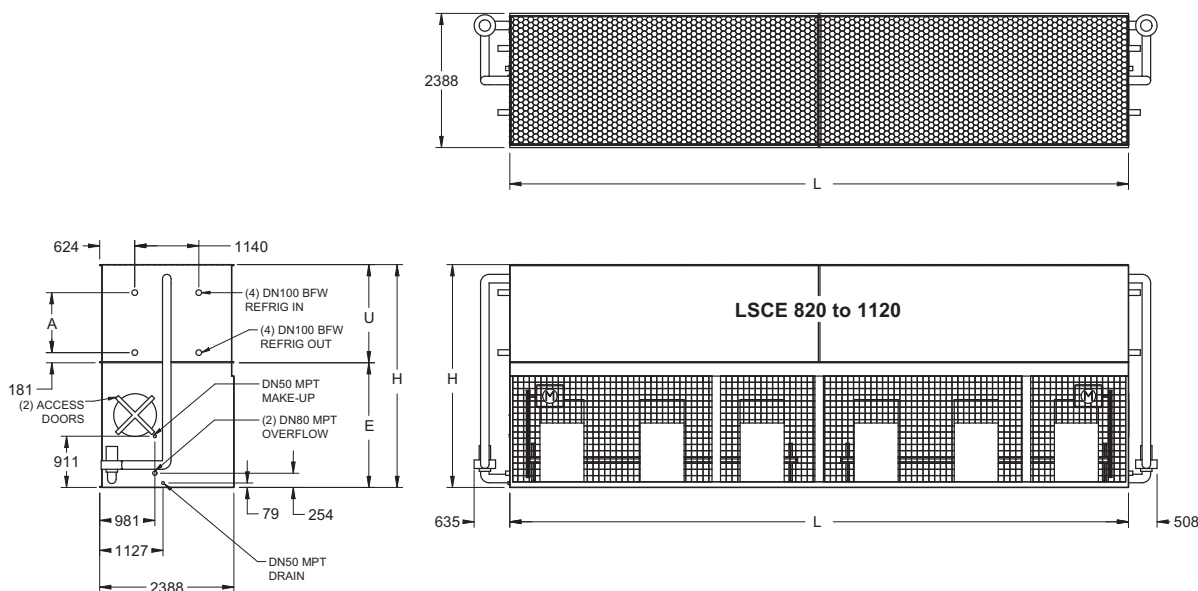

Model No.	Fans		Weights (kg)			Refrigerant Operating Charge (kg)	Coil Volume (l)	Spray Pump kW	Remote Pump			Dimensions (mm)				
	kW	m³/s	Shipping	Operating	Heaviest Section*				Liters Req'd**	Conn. Size (mm)	Operating Weight	Height H	Length L	Lower E	Upper U	Coil A
LSCE 820	(2) 18.5	63,4	14610	19980	5300	346	2944	(2) 5.5	4015	(2) 300	17565	3585	11024	2219	1365	686
LSCE 861	(2) 22	67,3	14700	20070	5345	346	2944	(2) 5.5	4015	(2) 300	17655	3585	11024	2219	1365	686
LSCE 920	(2) 30	74,1	14990	20360	5490	346	2944	(2) 5.5	4015	(2) 300	17945	3585	11024	2219	1365	686
LSCE 950	(2) 22	66	16605	22140	6295	430	3655	(2) 5.5	4015	(2) 300	19890	3775	11024	2219	1556	876
LSCE 980	(2) 37	79,9	15010	20380	5500	346	2944	(2) 5.5	4015	(2) 300	17960	3585	11024	2219	1365	686
LSCE 1020	(2) 30	72,6	16895	22430	6440	430	3655	(2) 5.5	4015	(2) 300	20180	3775	11024	2219	1556	876
LSCE 1060	(2) 30	71,2	18890	24580	7440	513	4366	(2) 5.5	4015	(2) 300	22475	3966	11024	2219	1746	1067
LSCE 1080	(2) 37	78,2	16915	22450	6450	430	3655	(2) 5.5	4015	(2) 300	20200	3775	11024	2219	1556	876
LSCE 1120	(2) 37	76,6	18910	24600	7450	513	4366	(2) 5.5	4015	(2) 300	22495	3966	11024	2219	1746	1067

* Heaviest section is the coil section

** Liters shown is water in suspension in unit and piping. Allow for additional water in bottom of remote sump to cover pump suction and strainer during operation. (300 mm would normally be sufficient.)

Refrigerant charge is shown for R-717. Multiply by 1.93 for R22, 1.98 for R134A and 1.7 for R404A, R410A and R507A.

Dimensions are subject to change. Do not use for pre-fabrication.

ENGINEERING DATA AND DIMENSIONS



Models LSCE 400 to 805

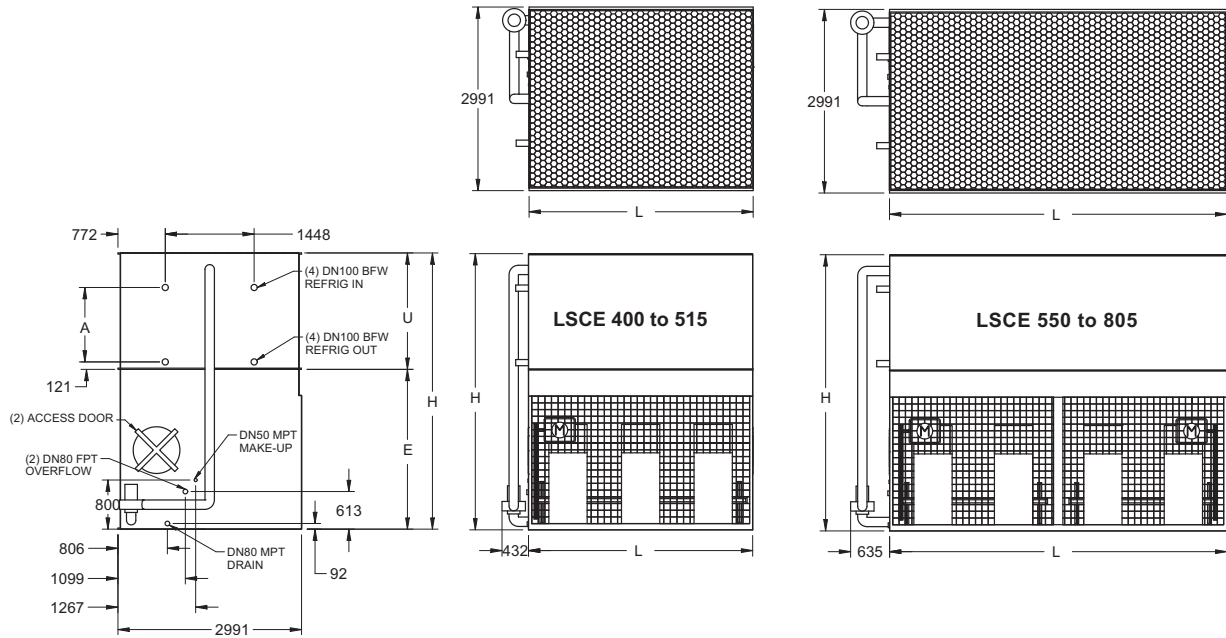

Model No.	Fans		Weights (kg)			Refrigerant Operating Charge (kg)	Coil Volume (l)	Spray Pump kW	Remote Pump			Dimensions (mm)				
	kW	m ³ /s	Shipping	Operating	Heaviest Section*				Liters Req'd**	Conn. Size (mm)	Operating Weight	Height H	Length L	Lower E	Upper U	Coil A
LSCE 400	22	31,6	6665	8920	4645	148	1258	4	1550	250	7985	4067	3651	2604	1464	781
LSCE 430	18,5	29,2	7460	9790	5445	183	1557	4	1550	250	8925	4283	3651	2604	1680	997
LSCE 450	22	31	7485	9810	5465	183	1557	4	1550	250	8950	4283	3651	2604	1680	997
LSCE 480	30	34,1	7555	9885	5540	183	1557	4	1550	250	9020	4283	3651	2604	1680	997
LSCE 500	30	33,4	8420	10815	6400	218	1855	4	1550	250	10035	4499	3651	2604	1895	1213
LSCE 515	37	36	8425	10820	6405	218	1855	4	1550	250	10040	4499	3651	2604	1895	1213
LSCE 550	(2) 11	41,6	9685	13115	6775	220	1868	5,5	2270	300	11620	4067	5493	2604	1464	781
LSCE 590	(2) 15	45,7	9740	13170	6830	220	1868	5,5	2270	300	11675	4067	5493	2604	1464	781
LSCE 625	(2) 18,5	49,3	9765	13195	6860	220	1868	5,5	2270	300	11705	4067	5493	2604	1464	781
LSCE 650	(2) 15	44,8	10970	14495	8060	273	2320	5,5	2270	300	13120	4283	5493	2604	1680	997
LSCE 690	(2) 18,5	48,3	10995	14525	8090	273	2320	5,5	2270	300	13150	4283	5493	2604	1680	997
LSCE 720	(2) 22	51,3	11040	14570	8135	273	2320	5,5	2270	300	13195	4283	5493	2604	1680	997
LSCE 755	(2) 22	50,3	12320	15950	9410	326	2771	5,5	2270	300	14685	4499	5493	2604	1895	1213
LSCE 805	(2) 30	55,3	12465	16095	9555	326	2771	5,5	2270	300	14830	4499	5493	2604	1895	1213

* Heaviest section is the coil section

** Liters shown is water in suspension in unit and piping. Allow for additional water in bottom of remote sump to cover pump suction and strainer during operation. (300 mm would normally be sufficient.)

Refrigerant charge is shown for R-717. Multiply by 1.93 for R22, 1.98 for R134A and 1.7 for R404A, R410A and R507A.

Dimensions are subject to change. Do not use for pre-fabrication.

LSCE

ENGINEERING DATA AND DIMENSIONS

Models LSCE 800 to 1030

ENGINEERING

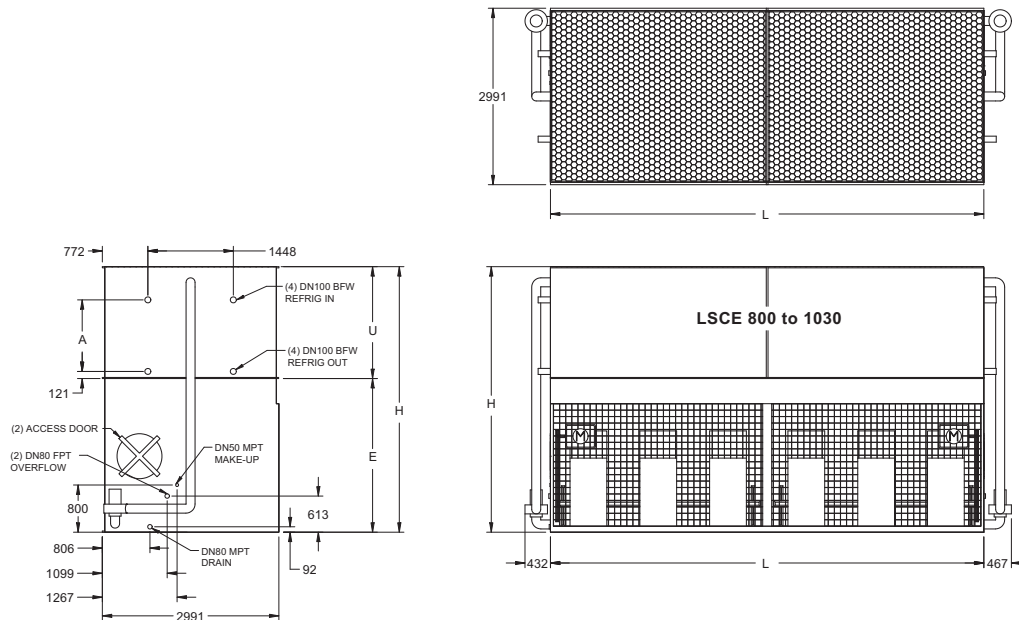

Model No.	Fans		Weights (kg)			Refrigerant Operating Charge (kg)	Coil Volume (l)	Spray Pump kW	Remote Pump			Dimensions (mm)				
	kW	m ³ /s	Shipping	Operating	Heaviest Section*				Liters Req'd**	Conn. Size (mm)	Operating Weight	Height H	Length L	Lower E	Upper U	Coil A
LSCE 800	(2) 22	63,3	13455	18045	4840	296	2515	(2) 4	3105	(2) 250	16010	4067	7347	2604	1464	781
LSCE 860	(2) 18.5	58,3	15015	19740	5620	366	3113	(2) 4	3105	(2) 250	17855	4283	7347	2604	1680	997
LSCE 900	(2) 22	62	15105	19830	5665	366	3113	(2) 4	3105	(2) 250	17945	4283	7347	2604	1680	997
LSCE 960	(2) 30	68,2	15395	20120	5810	366	3113	(2) 4	3105	(2) 250	18235	4283	7347	2604	1680	997
LSCE 1000	(2) 30	66,8	17120	21980	6670	436	3711	(2) 4	3105	(2) 250	20245	4499	7347	2604	1895	1213
LSCE 1030	(2) 37	72	17135	22000	6680	436	3711	(2) 4	3105	(2) 250	20260	4499	7347	2604	1895	1213

* Heaviest section is the coil section

** Liters shown is water in suspension in unit and piping. Allow for additional water in bottom of remote sump to cover pump suction and strainer during operation. (300 mm would normally be sufficient.)

Refrigerant charge is shown for R-717. Multiply by 1.93 for R22, 1.98 for R134A and 1.7 for R404A, R410A and R507A.

Dimensions are subject to change. Do not use for pre-fabrication.

ENGINEERING DATA AND DIMENSIONS



Models LSCE 1100 to 1610

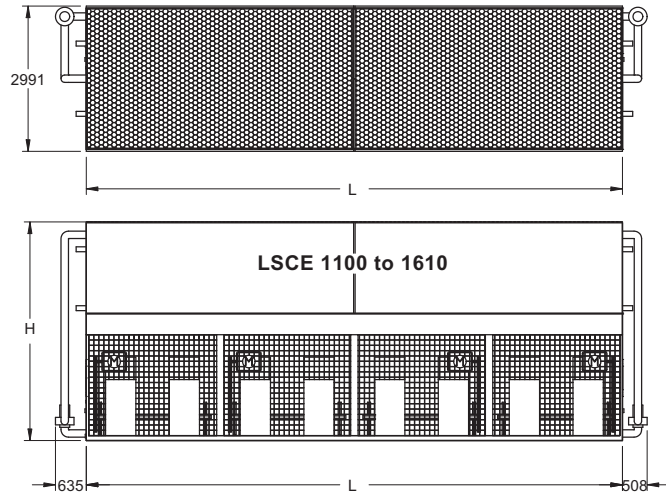
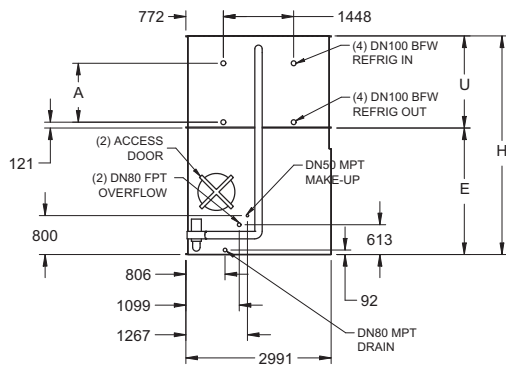

Model No.	Fans		Weights (kg)			Refrigerant Operating Charge (kg)	Coil Volume (l)	Spray Pump kW	Remote Pump			Dimensions (mm)				
	kW	m³/s	Shipping	Operating	Heaviest Section*				Liters Req'd**	Conn. Size (mm)	Operating Weight	Height H	Length L	Lower E	Upper U	Coil A
LSCE 1100	(4) 11	83,1	19885	26750	7050	439	3736	(2) 5.5	5680	(2) 300	23815	4067	11036	2604	1464	781
LSCE 1180	(4) 15	91,4	20105	26965	7160	439	3736	(2) 5.5	5680	(2) 300	24030	4067	11036	2604	1464	781
LSCE 1250	(4) 18.5	98,5	20210	27075	7210	439	3736	(2) 5.5	5680	(2) 300	24140	4067	11036	2604	1464	781
LSCE 1310	(4) 22	104,7	20395	27255	7305	439	3736	(2) 5.5	5680	(2) 300	24320	4067	11036	2604	1464	781
LSCE 1380	(4) 18.5	96,5	22670	29735	8440	545	4639	(2) 5.5	5680	(2) 300	27035	4283	11036	2604	1680	997
LSCE 1440	(4) 22	102,6	22850	29915	8530	545	4639	(2) 5.5	5680	(2) 300	27215	4283	11036	2604	1680	997
LSCE 1510	(4) 22	100,5	25400	32665	9805	652	5542	(2) 5.5	5680	(2) 300	30200	4499	11036	2604	1895	1213
LSCE 1610	(4) 30	110,6	25980	33245	10095	652	5542	(2) 5.5	5680	(2) 300	30780	4499	11036	2604	1895	1213

* Heaviest section is the coil section

** Liters shown is water in suspension in unit and piping. Allow for additional water in bottom of remote sump to cover pump suction and strainer during operation. (300 mm would normally be sufficient.)

Refrigerant charge is shown for R-717. Multiply by 1.93 for R22, 1.98 for R134A and 1.7 for R404A, R410A and R507A.

Dimensions are subject to change. Do not use for pre-fabrication.

LSCE

ENGINEERING DATA AND DIMENSIONS

ENGINEERING

Structural Steel Support

The recommended method of support for the LSCE condenser is two structural "I" beams located under the outer flanges and running the entire length of the unit. Mounting holes, 19 mm in diameter, are located at the bottom channels of the pan section to provide for bolting to the structural steel. Refer to certified drawings from the factory for bolt hole locations. See the drawing and chart below for unit dimensions.

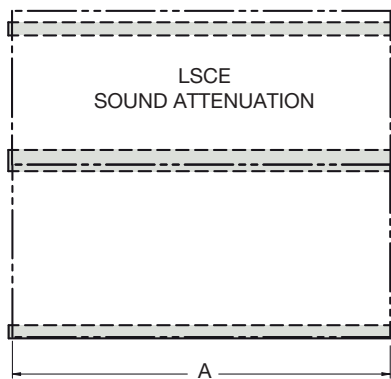

Plan View

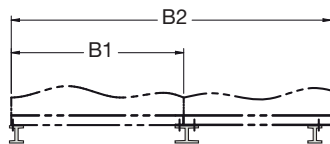

End Elevation

LSCE DIMENSIONS					
			Compact	Basic	Extended
Box size	A	B1	B2	B2	B2
4x6	1826	1235	2378	2648	3048
4x9	2724	1235	2378	2648	3048
4x12	3645	1235	2378	2648	3048
4x18	5486	1235	2378	2648	3048
5x12	3645	1651	2794	3064	3453
5x18	5483	1651	2794	3064	3453
8x12	3651	2388	3531	3800	4188
8x18	5486	2388	3531	3800	4188
8x24	7341	2388	3531	3800	4188
8x36	11011	2388	3531	3800	4188
10x12	3651	2991	4134	4404	4791
10x18	5493	2991	4134	4404	4791
10x24	7344	2991	4134	4404	4791
10x36	11027	2991	4134	4404	4791

Note:

- 1) Beams should be level to within 1/360 of unit length, not to exceed 13 mm before setting the unit in place.
- 2) Do not level the unit by shimming between it and the "I" beams as this will not provide proper longitudinal support.
- 3) Beams should be sized in accordance with accepted structural practices. Support beams and anchor bolts are to be furnished by others.

SPECIFICATIONS

LSCE

1.0 FORCED DRAFT EVAPORATIVE CONDENSER

1.1 General

Furnish and install factory assembled evaporative condenser of blow through, counterflow design with a horizontal single air side entry and a vertical air discharge. The unit shall be completely factory assembled and be conform to the specifications and schedules.

The condenser shall reject _____ kW of heat with _____ as refrigerant and _____ °C condensation temperature at a wet bulb temperature of _____ °C.

The total fan power should not exceed _____ kW and the total overall unit dimensions should not exceed the following :

Length: mm
Width: mm
Height: mm

The unit will be delivered in two parts: the section (pan-fan) and the top section (heat transfer).

The unit (top and bottom section) shall be joined together with elastic sealer and bolted together with corrosion resistance fasteners.

Approved manufacturer: Evapco – model LSCE _____

1.2 Thermal Performance – Performance Warranty

The condenser shall be capable of performing the thermal duties as shown in the schedule and on drawings, and its design thermal rating shall be guaranteed by the manufacturer.

1.3 Applicable Standards

CTI ATC 128 Test Code for Measurement of Sound from Water Cooling Towers.

1.4 Submittals

- a) The manufacturer shall submit a five year history of the proposed type of evaporative condenser with a minimum of 10 installations for similar sized equipment.
- b) Shop drawings: submit shop drawings indicating dimensions, weight loadings and required clearances.
- c) Product data: submit manufacturer's technical product data, original selection printouts and clearance requirements.
- d) Complete noise data sheet for the selected evaporative condenser.
- e) Maintenance data for the evaporative condenser and accessories.
- f) The evaporative condenser manufacturer shall provide factory test run certificates of the fans and fan motor.

1.5 Product Delivery – Storage and Handling

- a) The contractor shall make the provisions for proper storage at site before installation and handle the product per the instructions of the manufacturer.
- b) Once installed provide the necessary measures that the units remain clean and protected from any dust and mechanical damage.

1.6 Quality Assurance

- a) The manufacturer shall have a quality assurance system in place which is certified by an accredited registrar and complying with the requirements of ISO 9001:2008. This is to guarantee a consistent level of product and service quality.
- b) Manufacturers without ISO 9001:2008 certification are not acceptable.

1.7 Warranty

- a) The products will be warranted for a period of minimum two years from the date of shipment.

2.0 PRODUCT

2.1 Construction – Corrosion Resistance

STANDARD EXECUTION – GALVANIZED STEEL Z-725

- a) The complete cold water basin shall be constructed of galvanized steel Z-725. The structure and all steel elements of the casing shall be constructed of Z-725 hot dip galvanized steel for long life and durability. Alternatives with lower zinc layer thickness and external paint or coating or FRP are not accepted as equal.
- b) The strainer shall be made of stainless steel type 304L.
- c) During fabrication all panel edges shall be coated with a 95% pure zinc compound.
- d) Casing materials shall be of non flammable construction.

OPTIONAL EXECUTION – BASIN IN SST 304L

- a) The structure and all steel elements of the pan up to the water level shall be made of SST 304L.
- b) Alternatives with hot dip galvanized steel and epoxy coatings in lieu of the SST 304 are not considered equal and will not be accepted.
- c) All other steel components and the casing shall be constructed of Z-725 hot dip galvanized steel for long life and durability. Alternatives with lower zinc layer thickness and external paint or coating are not accepted as equal.
- d) The strainer shall be made of stainless steel type 304L.
- e) During fabrication all galvanized steel panel edges shall be coated with a 95 % pure zinc compound.
- f) Casing materials shall be of non flammable construction.

OPTIONAL EXECUTION – COMPLETE UNIT IN STAINLESS STEEL SST 304L (except moving parts and heat exchanger coils)

- a) The structure and all steel elements shall be made of SST 304L.
- b) Alternatives with hot dip galvanized steel and epoxy coatings to replace the SST 304L are not considered equal and accepted.
- c) Casing materials shall be of non flammable construction.

2.2 Construction – Seismic and wind load resistance

- a) The structural design must withstand 1g seismic or 6.94 kN/m² wind loads.
- b) Cooling Towers must be independently certified according to IBC 2012.

2.3 Pan / Fan section

- a) The heat transfer section shall be removable from the pan to provide easy handling and rigging.
- b) The pan - fan section shall include fans and drives mounted and aligned in the factory. These items shall be located in the dry air stream.
- c) Standard pan accessories shall included circular access doors, strainer(s) of anti vortex design, brass make up valve with unsinkable, foam filled plastic float arranged for easy adjustment.
- d) The basin bottom shall be sloped to provide drainage of the complete basin section.

2.4 Mechanical Equipment

2.4.1 Fan(s)

- a) Fans shall be dynamically balanced forwardly curved centrifugal type fans.
- b) Fan housings shall have curved inlet rings for efficient air entry and rectangular discharge cowls which extend into the basin to increase fan efficiency and to prevent water from splashing into the fans.
- c) Curved inlet rings shall be made of the same material as the evaporative condenser.
- d) All fans will undergo a dry running test in the factory after being installed in the evaporative condenser basin.

LSCE

SPECIFICATIONS

- e) The fans will be mounted on either a solid or a hollow shaft with forged bearing journals.
- f) Easy to remove fan screens shall be provided to avoid direct contact with the moving parts.

2.4.2 Bearings and Drive

- a) The fan shaft(s) shall be supported by heavy duty, self aligning pillow block bearings with cast iron housings and lubrication fittings for maintenance.
- b) The fan drives shall be V belt type with taper lock sheaves designed for 150% of the motor nameplate horsepower.
- c) The bearings shall be rated for an L-10 life of 40.000 hours.

2.4.3 Motor

- a) The fan motor shall be Totally Enclosed, Fan Cooled (TEFC), squirrel cage, ball bearing type motor.
- b) The motor shall be minimum IP 55 degree of protection, Class F insulation, Service Factor 1 and selected for the appropriate evaporative condenser duty and the correct ambient temperature but minimum 40°C.
- c) Motor bearings shall be greased for life or external grease lines shall be provided.
- d) The motor shall be mounted on an adjustable heavy duty steel motor base.
- e) The motor selection shall be selected for the appropriate external static pressure.
- f) The motor power supply shall be ___ volts, ___ Hertz and ___ Phase.

2.5. Casing Section

2.5.1 Heat Transfer Coil

- a) The evaporative condenser shall use internally enhanced heat exchange coils of an elliptical tube design to obtain lower air flow resistance and allow higher water loadings around the tubes.
- b) The heat transfer coil(s) shall be made of all prime surface, encased in a steel framework and hot dip galvanized after fabrication as a complete assembly.
- c) The tubes shall be arranged in a self spacing, staggered pattern in the direction of air flow for maximum heat transfer efficiency and minimum pressure drop.
- d) The heat exchange coils shall be air pressure tested under water.
- e) The design and manufacturing process shall be approved and in accordance with the "Pressure Equipment Directive" – PED 97 / 23 EC.
- f) The manufacturer shall be responsible for the manufacturing and performance testing of the entire heat transfer coil. This is to assure single source responsibility.
- g) The casing shall totally encase the complete coil section to protect the complete coil from direct atmospheric contact.
- h) The pressure drop of the process fluid through the coil shall not exceed ___ kPa.

OPTIONAL - Heat Transfer Coil in SST 304L

- a) The evaporative condenser shall use heat exchange coils of an elliptical tube design to obtain lower air flow resistance and allow higher water loadings around the tubes.
- b) The heat transfer coil(s) shall be made of SST 304L encased in an SST 304L framework and passivated after fabrication as a complete assembly.
- c) The tubes shall be arranged in a self spacing, staggered pattern in the direction of air flow for maximum heat transfer efficiency and minimum pressure drop.
- d) The heat exchange coils shall be air pressure tested under water.
- e) The design and manufacturing process shall be approved and in accordance with the "Pressure Equipment Directive" – PED 97 / 23 EC.
- f) The manufacturer shall be responsible for the manufacturing and performance testing of the entire heat transfer coil. This is to assure single source responsibility.
- g) The casing shall totally encase the complete coil section to protect the complete coil from direct atmospheric contact.

- h) The pressure drop of the process fluid through the coil shall not exceed ___ kPa.

2.5.2 Water Distribution

- a) The spray header and branches shall be constructed of Schedule 40, Polyvinyl Chloride (PVC) pipe for corrosion resistance and shall have a steel connection to attach the external piping.
- b) The internal tower water distribution piping shall be easily removable for cleaning purposes.
- c) The water shall be distributed over the fill by precision molded ABS spray nozzles with large minimum 32 mm orifice openings and integral sludge ring to eliminate clogging.
- d) The nozzles shall be threaded into the water distribution piping to assure positive positioning.
- e) Each cell shall have only one hot water return inlet, otherwise the evaporative condenser manufacturer shall provide the necessary extra provisions (piping, balancing valves, ...) to achieve the same at no extra cost.

2.5.3 Drift Eliminators

- a) The drift eliminators shall be constructed entirely inert polyvinyl (PVC) that has been specially treated to resist ultra violet light.
- b) Assembled in easily handled sections, the eliminator blades shall be spaced on 25 mm centers and shall incorporate three changes in air direction to assure efficient removal of entrained moisture from the discharge air stream.
- c) The maximum drift rate shall not exceed 0,001% of the recirculated water rate.
- d) The Drift Eliminators' performance shall be certified according to Eurovent Standard OM-14-2009.

2.6 Sound Levels

The maximum sound pressure levels (dB) as per CTI ATC 128 measured 15 m from the evaporative condenser operating at full fan speed shall not exceed the sound levels detailed below.

Location	63Hz	125Hz	250Hz	500Hz	1000Hz	2000Hz	4000Hz	8000Hz	dB(A)
Fan Discharge									
Air inlet/end									

3.0 ACCESSORIES (optional)

3.1 Electric Heaters

- a) The evaporative condenser cold water basin shall be provided with a electric heater package to prevent freezing of the water in the cold water basin.
- b) The electric heater package includes: electric heater elements and a combination of thermostat and low water level cutoff.
- c) The heaters shall be selected to maintain +4°C to +5°C basin water temperature at ___°C ambient.
- d) The heater(s) shall be ___V / ___ phase / ___ Hz electric power supply.

3.2 Three Probe Electric Water Level Control Package

- a) The evaporative condenser manufacturer shall provide an electric water level control package instead of the mechanical float valve arrangement.
- b) The package consist of the following elements:
 - Multiple heavy duty stainless steel SST 316 static probes mounted in a stilling chamber outside the unit. Electrodes or sensors mounted inside the unit are not accepted because the functionality will be disturbed by the moving water in the basin.
 - An ABS, IP 56 case contains all the contactors for the different level probes and will provide an output signal for automatic filling and a level alarm.
 - The power supply to the control package is 24 Vac / 230 Vac - ___ Hz.
 - A weather protected solenoid valve (PN16) for the water make up ready for piping to a water supply with pressure between 0,35 kPa and 700 kPa.

SPECIFICATIONS

LSCE

3.3 Intake Sound Attenuation

- a) The unit will be equipped with intake sound attenuation consisting of a hot dip galvanized steel housing of the same quality of the unit and completed with acoustical baffles made of fiberglass material which is suitable for use in evaporative condensers.
- b) The intake sound attenuator is provided with large access doors which allow access to maintain the fans and bearings.
- c) The evaporative condenser motor size must be adjusted for the additional static pressure drop caused by the sound attenuator.

3.4 Discharge Sound Attenuation

- a) The unit will be equipped with discharge sound attenuation consisting of a hot dip galvanized steel housing of the same quality of the unit and completed with acoustical baffles made of fiberglass material which is suitable for use in evaporative condensers.
- b) The discharge sound attenuator is provided with large access doors which allow access to maintain the water distribution system and the drift eliminators without removing the baffles.
- c) The evaporative condenser motor size must be adjusted for the additional static pressure drop caused by the sound attenuator.

3.5 Vibration Switch

- a) A vibration limit switch shall be installed on the mechanical equipment support and wired into the control panel. The purpose of this switch will be to interrupt power the motor in the event of excessive vibration.
- b) The switch shall be adjustable for sensitivity, and shall require manual reset.



★ World Headquarters/
Research and
Development Center

■ EVAPCO Manufacturing
Locations

EVAPCO, Inc. — World Headquarters & Research / Development Center

P.O. Box 1300 • Westminister, MD 21158 USA
410.756.2600 • marketing@evapco.com • evapco.com

North America

EVAPCO, Inc.
World Headquarters
Westminister, MD USA
410.756.2600
marketing@evapco.com

EVAPCO East
Taneytown, MD USA
410.756.2600
marketing@evapco.com

EVAPCO East
Key Building
Taneytown, MD USA
410.756.2600
marketing@evapco.com

EVAPCO Midwest
Greenup, IL USA
217.923.3431
evapcomw@evapcomw.com

EVAPCO West
Madera, CA USA
559.673.2207
contact@evapcowest.com

EVAPCO Iowa
Lake View, IA USA
712.657.3223

EVAPCO Iowa
Sales & Engineering
Newford, MN USA
507.446.8005
evapcomn@evapcomn.com

EVAPCO Newton
Newton, IL USA
618.783.3433
evapcomw@evapcomw.com

Evapcold Manufacturing
Greenup, IL USA
217.923.3431
evapcomw@evapcomw.com

EVAPCO Dry Cooling, Inc.
Bridgewater, NJ USA
908.379.2665
info@evapcodc.com

EVAPCO Dry Cooling, Inc.
Littleton, CO USA
908.379.2665
info@evapcodc.com
Spare Parts: 908.895.3236
Spare Parts: spares@evapcodc.com

EVAPCO Power México S. de R.L. de C.V.
Mexico City, Mexico
(52) 55.8421.9260
info@evapcodc.com

Refrigeration Vessels & Systems Corporation
A wholly owned subsidiary of EVAPCO, Inc.
Bryan, TX USA
979.778.0095
rvs@rvscorp.com

EvapTech, Inc.
A wholly owned subsidiary of EVAPCO, Inc.
Edwardsville, KS USA
913.322.5165
marketing@evaptech.com

Tower Components, Inc.
A wholly owned subsidiary of EVAPCO, Inc.
Ramseur, NC USA
336.824.2102
mail@towercomponentsinc.com

EVAPCO Alcoil, Inc.
A wholly owned subsidiary of EVAPCO, Inc.
York, PA USA
717.347.7500
info@evapco-alcoil.com

Europe

EVAPCO Europe
EMENA Headquarters
Tongeren, Belgium
(32) 12.39.50.29
evapco.europe@evapco.be

EVAPCO Europe BVBA
Tongeren, Belgium
(32) 12.39.50.29
evapco.europe@evapco.be

EVAPCO Europe, S.r.l.
Milan, Italy
(39) 02.939.9041
evapcoeuropa@evapco.it

EVAPCO Europe, S.r.l.
Sondrio, Italy

EVAPCO Europe GmbH
Meerbusch, Germany
(49) 2159.69560
info@evapco.de

EVAPCO Europe A/S
Aabybro, Denmark
(45) 9824.4999
info@evapco.dk

Evap Egypt Engineering Industries Co.
A licensed manufacturer of EVAPCO, Inc.
Nasr City, Cairo, Egypt
(20) 10 05432198
mmanz@tiba-group.com /
hany@tiba-group.com

EVAPCO Middle East DMCC
Dubai, United Arab Emirates
(971) 56.991.6584
info@evapco.ae

EVAPCO S.A. (Pty.) Ltd.
A licensed manufacturer of EVAPCO, Inc.
Isando, South Africa
(27) 11.392.6630
evapco@evapco.co.za

Asia Pacific

EVAPCO Asia Pacific
Headquarters
Baoshan Industrial Zone
Shanghai, P.R. China
(86) 21.6687.7786
marketing@evapcochina.com

EVAPCO (Shanghai) Refrigeration Equip. Co., Ltd.
Baoshan Industrial Zone, Shanghai, P.R. China
(86) 21.6687.7786
marketing@evapcochina.com

EVAPCO (Beijing) Refrigeration Equip. Co., Ltd.
Huairou District, Beijing, P.R. China
(86) 10.6166.7238
marketing@evapcochina.com

EVAPCO Air Cooling Systems (Jiaxing) Comp., Ltd.
Jiaxing, Zhejiang, China
(86) 573.8311.9379
info@evapcochina.com

EVAPCO Australia (Pty.) Ltd.
Riverstone, NSW, Australia
(61) 02.9627.3322
sales@evapco.com.au

EvapTech Asia Pacific Sdn. Bhd
A wholly owned subsidiary of EvapTech, Inc.
Puchong, Selangor, Malaysia
(60) 3.8070.7255
marketing-ap@evaptech.com

South America

EVAPCO Brasil
Equipamentos Industriais Ltda.
Indaiatuba, São Paulo, Brazil
(55) 11.5681.2000
vendas@evapco.com.br

FanTR Technology Resources
Itu, São Paulo, Brazil
(55) 11.4025.1670
fantr@fantr.com