

LOW-CHARGE SOLUTIONS WITH AHRI-CERTIFIED PERFORMANCE

Bulletin 415

SST-B

SERIES *Industrial Evaporators*



Independently Certified in
Accordance with AHRI Standard 420
Performance Rating Standard



IARW International Association of
Refrigerated Warehouses





Get to Know EVAPCO

- The global innovator in heat transfer solutions
- Serving the commercial HVAC, industrial refrigeration, power generation, and industrial processing markets
- Founded in 1976
- Employee-owned
- 22 manufacturing facilities in 10 countries
- More than 170 sales offices in 42 countries

Find your EVAPCO representative now at evapco.com.

EVAPCO is more than a name.

It's a pledge to make everyday life easier, more comfortable, more reliable, and more sustainable for people everywhere. How do we fulfill on that promise? It's simple.

We never stop innovating.

At EVAPCO, we don't just talk about innovation. It's ingrained in our workflow. Guided by our annually developed R&D plans, we set out every day to find groundbreaking solutions that transform the way the world works for the better. It's why we have more than 25 patents worldwide in the last 10 years alone.

We craft exceptionally built solutions.

As an employee-owned company, we are loyal. We demand excellence of one another. And we take pride in our work. Together, we make up one of the most experienced teams of engineers and craftsmen in the industry. This translates into solutions that are always exceptionally built. No one will deliver higher quality for you.

We guarantee performance.

Every EVAPCO solution is put through rigorous research and testing to deliver maximum efficiency and reliability. But we don't stop there. We also lead the industry in independent, third-party performance certifications. These certifications guarantee our performance metrics—so that you can plan your projects with complete peace of mind.

We protect the environment.

Innovation and environmental sustainability go hand-in-hand at EVAPCO. From sound reduction to water conservation to chemical elimination, we are constantly developing new technologies that deliver the ultimate operating advantages for our clients—and protect the planet for every generation that comes after us.

We are EVAPCO—the team you can count on for life.

SST-B SERIES

Guaranteed Evaporator Performance Designed to Minimize Refrigerant Charge

In 2014, EVAPCO brought you the industry's first line of evaporators rated in accordance with AHRI Standard 420 and certified under the AHRI Unit Coolers Certification Program. The SST-B Series has now been expanded with two NEW product lines featuring the same end user features and benefits with reduced refrigerant charge.

Standard Fin Spacing

SST-B Series evaporators are designed around a coil platform featuring 3.3, 4.3, and 6 FPI fin spacing. Fins are available in 0.014-inch thick flat, 0.014-inch thick CHANNELFLOW-enhanced, and 0.028-inch flat heavy fin options. Pre-coated epoxy fin is available on all three options. Stainless steel fins are also available for highly corrosive applications.

8 Ceiling-Hung Models. More Possibilities.



SSTMB

Small to Medium Unit Cooler



NEW! SSTSB

Small to Medium
Low-Charge Unit Coolers

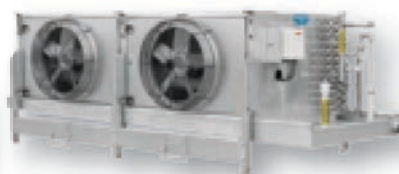

SSTXB

Small to Medium Low-Profile
Unit Cooler

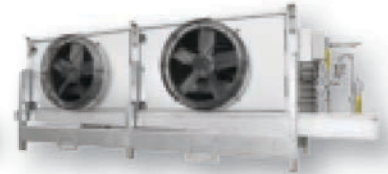

NEW! SSTEB

Small to Medium Low-Profile/
Low-Charge Unit Coolers



SSTLB

Large Product Cooler



SSTHB

Reduced Charge
Medium to Large
Hybrid Product Cooler



SSTWB*

Workroom Unit



SSTDB Low-Profile Coolers*

Dual-Coil, Low-Profile
Unit Cooler

**These models fall outside the scope of the AHRI Unit Coolers Certification Program, but are rated in accordance with AHRI Standard 420.*

Why AHRI Certification Matters

Historically, evaporator manufacturers have based their published thermal performance ratings on varying methodologies—including their own unique ratings methods. Thermal testing and ratings using AHRI Standard 420 (Performance Rating of Forced-Circulation Free-Delivery Unit Coolers for Refrigeration) have proven that these historical approaches can lead to significantly undersized units which must work overtime to meet the cooling needs of your refrigeration system.

The Ultimate Assurance of Product Performance

AHRI's Unit Cooler Certification Program levels the playing field. It uses stringent laboratory testing guidelines and thorough documentation in accordance with AHRI Standard 420 to verify that evaporators will perform in your facility as certified by the manufacturer.

Questions about Evaporator Ratings	AHRI Standard 420*
Relative Humidity: Evaporator cooling capacity is significantly affected by the humidity of the air. Equipment manufacturers may assume a high relative humidity to increase the evaporators rated capacity.	Specifies relative humidity for each of the five (5) Standard Rating Conditions. (Section 4. Test Requirements)
Sensible vs. Latent vs. Total Heat Ratings: Equipment manufacturers may take credit for the latent heat associated with removing water from the refrigerated space.	Dry Rating Condition has no latent cooling present. Wet Rating Condition has both sensible and latent cooling present. (Section 3.10.9 Definitions)
Temperature Difference: Normally defined as the difference between the room temperature and the coil temperature. Equipment manufacturers may use room mean air temperature (DTM ratings method) in developing their ratings.	Clearly defined as the difference between the dry bulb temperature of <u>entering air</u> and the Refrigerant Saturation Temperature at the coil outlet. (Section 3.16. Definitions)
Fan Motor Horsepower: Equipment manufacturers may exceed a fan motor's nameplate horsepower without notifying the end user.	Requires documented and certified power ratings. (Section 3.9. Rated Power)
Rated Performance: Based on theoretical analysis or actual tests conducted in a laboratory.	AHRI Certification requires annual performance verification from tests in an AHRI Approved Laboratory. (AHRI UC Operations Manual)

* Visit www.ahrinet.org for AHRI Standard 420: Performance Rating of Forced-Circulation Free-Delivery Unit Coolers for Refrigeration.

AHRI Certification Gives You Every Advantage:

- **Peace of Mind:** Thermal performance and power ratings are independently, third-party verified.
- **Consistency:** All participating manufacturers must rate their products using the same methods, including models NOT within the scope of the AHRI Certification Program.
- **Better Informed Decision-Making:** Room load calculations don't require excessive safety. Competitive evaporator proposals are easier to evaluate; purchases can be made with confidence; and ROI can be accurately evaluated.

Demand AHRI Certification! Turn to page 17 or go to evapco.com to see suggested Thermal Performance Guarantee Specification language for your contracts and specifications.

Innovative Coil Technology

CROSSCOOL™

Enhanced Tube Technology

All SST-B Series' stainless steel tubes feature CROSSCOOL™, an internally embossed design that improves the internal film coefficient for more efficient heat transfer. As a result, less refrigerant is required to coat the inside surface of the tubes. The benefits quickly add up:

- Reduced refrigerant charge
- Reduced refrigerant pump horsepower
- Lower operating cost
- Smaller line sizes and reduced overall installation cost

Recirculation Rate at AHRI-Certified Evaporator Performance Ratings

Tube Diameter	Recirculation Rate
0.375"	1.2:1
0.625"	1.2:1
1.05"	1.8:1

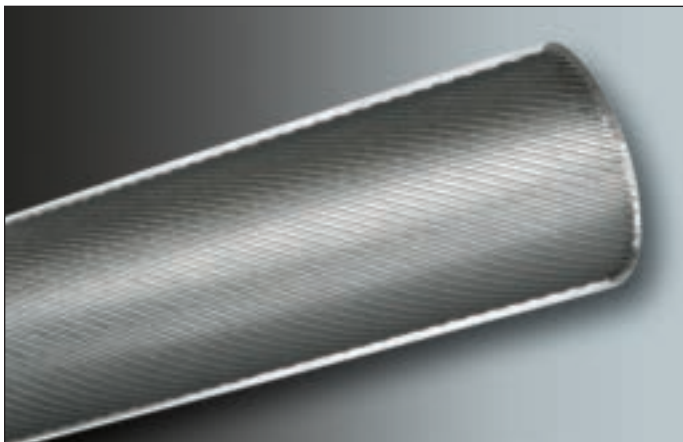

CHANNELFLOW

Fin Technology

The SST-B Series also features CHANNELFLOW, EVAPCO's patented enhanced aluminum fin technology that's proven to minimize airside pressure drop while improving overall heat transfer performance. The unique fin design allows for free drainage of condensate during wet operation without water carryover.

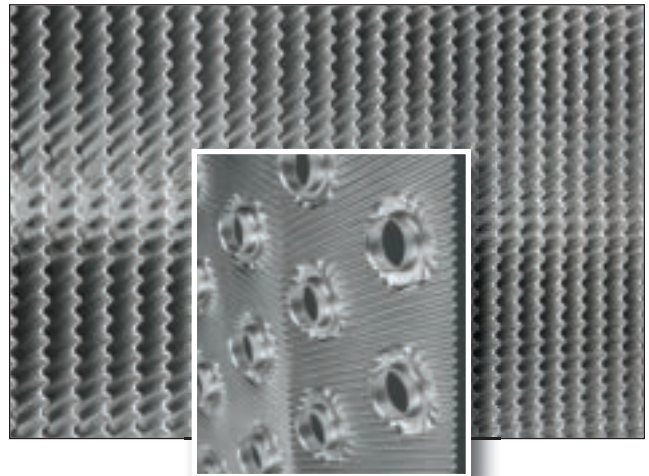

Guided by the fin plate's pattern, condensate and/or defrost water travel toward the center of the plate, collecting and facilitating the removal of debris and creating a more sanitary operation.

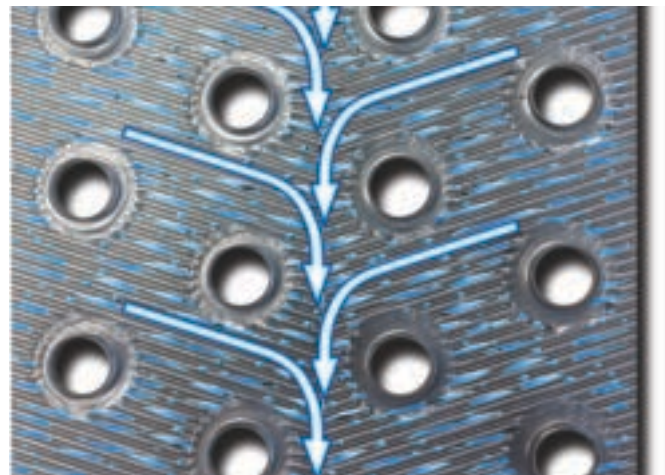

US Patent No. 6315804

Optimized Coil Design

Heat Exchanger Coil

EVAPCO has long been the industry innovator in heat exchanger coil design. In the early 1990s, EVAPCO introduced the Thermal-Pak® Finned Coil which revolutionized the industry. Now, the SST-B Series features our highest performance coil design yet. The coil tube diameter, geometry, and circuiting have been optimized through thousands of hours of theoretical modeling and laboratory testing. The result is optimal heat transfer efficiency with low airside pressure drop and low motor horsepower per ton.

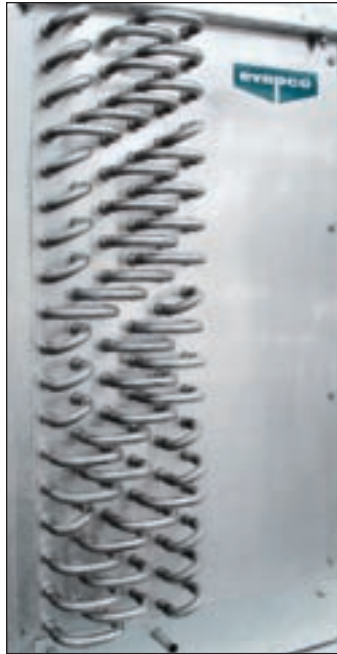

Coil Design

Through the use of computational fluid dynamics (CFD) modeling software, finite element heat transfer analysis, and proprietary coil performance calculation methods, EVAPCO engineers have identified significant design elements to improve the finned coil performance. The extensive computer modeling has been refined and verified through coil performance evaluation in EVAPCO's research laboratory.

Optimized Coil Circuiting

Industrial refrigeration experience demonstrates that coil circuiting must be designed to match the heat transfer load for a specific refrigerant at the operating temperature. The circuiting program used on all EVAPCO coils has been optimized based on actual coil operation in EVAPCO's research laboratory. Refrigerant flow and pressure-drop measurements have been matched against coil performance to find the optimum circuiting pattern for a given set of flow and temperature conditions. Optimizing the number of circuits and the circuiting pattern improves the heat transfer efficiency of the coil system and lowers annual operating cost for you.

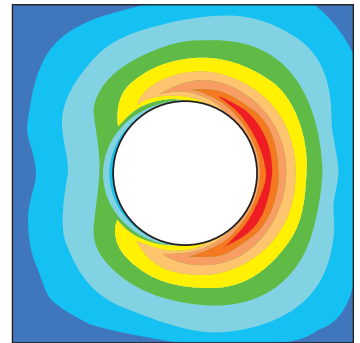

The EVAPCO Wilson E. Bradley Research & Development Center

Featuring a state-of-the-art, low-temperature, insulated environmental test chamber and a fully functional ammonia refrigeration system designed to operate at suction temperatures as low as -60°F, the EVAPCO Research & Development Center enables us to find groundbreaking solutions for the industry's biggest challenges.



Advanced Materials & Design Features

Superior Stainless Steel Technology

SST-B Series evaporators are constructed with high-grade type 304L stainless steel tubing and aluminum fins as standard. The stainless steel tubing meets the requirements of ASME B31.5 refrigerant piping code. The tubing is roll formed and continuously welded, annealed, and tested using an eddy current device.

The round tubing is fit into the aluminum fin plate and hydraulically expanded. This procedure provides more consistent contact between the tube and the fin plate than mechanical expansion. The entire coil is then pressure tested to 390 psig. Lastly, the coil is evacuated and charged with low-pressure nitrogen prior to shipment.

EVAPCO's stainless steel tubes are available in 3/8-inch OD, 5/8-inch OD and 1.05-inch OD. Coils are built in 3.3, 4.3 and 6 FPI as standard using a full-collar aluminum fin featuring EVAPCO's cleaner CHANNELFLOW fin technology. (Learn more about CHANNELFLOW on page 5). Variable fin spacing is available as an option.

For applications where corrosion of the aluminum fin is a concern, EVAPCO offers pre-coated epoxy fin stock.

EVAPCO also offers high performance stainless steel fins for those applications where coatings are not acceptable, including any installation near open food products and production areas.

Stronger Corrosion Protection

In SST-B Series evaporators, casings and drain pans are constructed from G-235 hot dip galvanized steel with an option for type 304 stainless steel*. G-235 is the highest level of mill galvanizing offered in the industry and exceeds the zinc protection that other manufacturers provide when using G-90 mill galvanized steel. The higher level of galvanizing provides a greater level of corrosion protection for a longer product life.

*SSTWB workroom units are manufactured with type 304 stainless steel casing panels and pan covers. The shipping supports are constructed from G-235 hot dip galvanized steel and should be removed after installation.

Low Sound Fans

EVAPCO's extensive air side research and testing has identified fans with the best combination of efficiency and sound levels. Fans used in SST-B Series evaporators have performance curves generated in EVAPCO's AMCA Fan



Cast Aluminum Fan Blades

Test Chamber. This ensures the fans perform as required to deliver the certified cooling effect and power ratings as stated in the equipment quotation and submitted data. Standard catalog models are selected to provide low sound levels. EVAPCO's low sound fan selections provide more comfort and a safer working environment for personnel entering the cold space. (SSTLB, SSTHB and SSTXB evaporators have cast aluminum fans as standard while cast blades are optional on most other models.)

Durable Fan Motors

All fan motors, including fractional horsepower fan motors, are foot-mounted for improved durability in a wide range of operating conditions. EVAPCO worked closely with leading motor manufacturers to develop fan motors specifically for evaporator applications. Fan motors on catalog models up to 1-1/2 horsepower are equipped with automatic thermal overload protection, and all fan motors are pre-wired to a NEMA 4X junction box. Fan motors are mounted on structural channels designed and built by EVAPCO to operate reliably and are guaranteed against structural failure caused by low temperature conditions.

Sloped Top Panels

The top panels of SST-B Series evaporators are sloped to prevent accumulation of moisture from condensation or clean-up cycles. Water from the top drains into an over-sized, full coverage drain pan, improving the cleanliness of the unit and preventing the possibility of product contamination.

Hygienic Drain Pans

Sloped in two directions to prevent water from pooling, the custom-engineered drain pans in SST-B Series evaporators are also equipped with swaged bottom outlets to ensure complete drainage. Drain pans are factory mounted prior to shipment.

Refer to the product pages starting on page 8 for additional construction details.

SSTMB Small & Medium Unit Coolers

Ideal for freezers, coolers and docks that require low-medium-and high-temperature applications, the SSTMB is equipped with many features that increase your ease of maintenance, improve the hygienic design of the evaporator, and provide a safer working environment for your team.

Exceptional Performance & Design:

- Optimized recirculation rate of 1.2:1 significantly reduces system refrigerant charge
- Smooth appearance with fewer breaks and seams
- Superior hygienic drain pan design covers the entire casing and coil connections, ensuring that all moisture is collected

The Easiest Evaporator to Clean, Maintain & Install:

- Hygienic cabinet design—all support angles and channels are turned inward
- Hinged fan panels allow easy access to fan motors, the air exit side of the coil, and the drain pan
- Drain pans are fully accessible with the wet coil baffles installed
- Wet coil baffles are installed in the middle of the coil to prevent air bypass and allow for drain pan access from both sides of the coil
- Ships with removable sheet metal channels for easy forklift handling—no shipping skids or crating disposal required

Standard:

- Heavy-wall, 0.625-inch diameter, stainless steel tubing featuring CROSSCOOL™ Enhanced Tube Technology
- Aluminum fin construction featuring CHANNELFLOW Fin Technology
- G-235 hot dip galvanized steel casing and dual-sloped drain pan
- Heavy-duty sheet metal fans

Options:

- One to five fan models
- Low sound fan motors ranging from 1/4 horsepower to 5 horsepower in 690, 870, 1160 and 1750 RPM.
- Cast aluminum fan blades for special low-temperature applications
- Ultra hygienic construction and EVAPCO Sanitary System (see page 26)
- See page 24 for custom options

AHRI Certified

In accordance with the AHRI Unit Cooler Certification Program Operations Manual (UCOM) the Thermal Performance and Rated Power (watts or horsepower) for each SSTMB evaporator has been determined and verified per Standard 420.



Shown with shipping and installation supports.

SSTMB Engineering Data

SSTMB Dimensional Data

SSTMB1

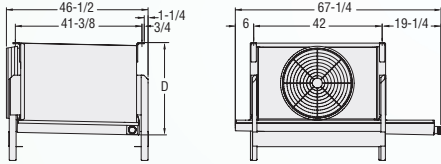

Model	*Tons	CFM	D Dimension
SSTMB1	1.3 - 8.7	2490 - 16330	30-1/4" - 54-1/4"
SSTMB2	2.5 - 17.2	4980 - 32660	31" - 55"
SSTMB3	3.7 - 26.2	7460 - 48980	31-7/8" - 55-7/8"
SSTMB4	5.1 - 35.0	9950 - 65310	32-3/4" - 56-3/4"
SSTMB5	6.3 - 43.7	12440 - 81630	33-5/8" - 57-5/8"

SSTMB2

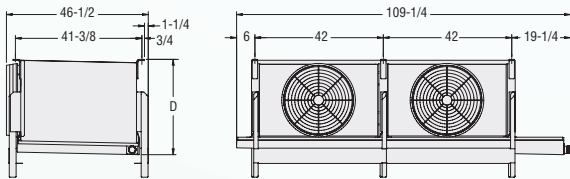

*Capacity is based on a dry coil rating with R-717 at 1.2 : 1.0 recirculation rate with 35°F entering air temperature and 25°F saturated suction temperature.

SSTMB3

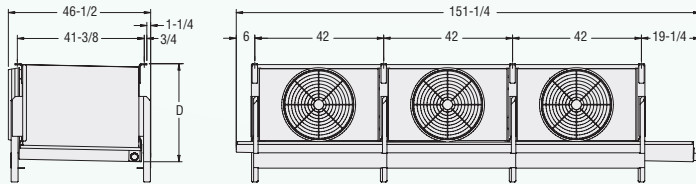

SSTMB4

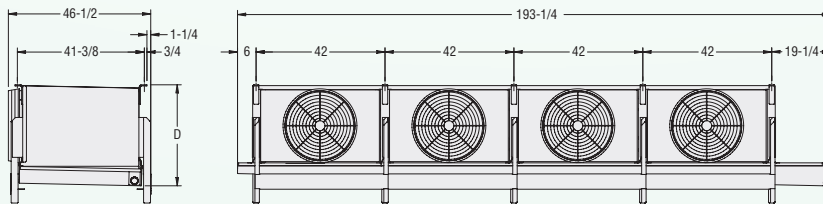

SSTMB5

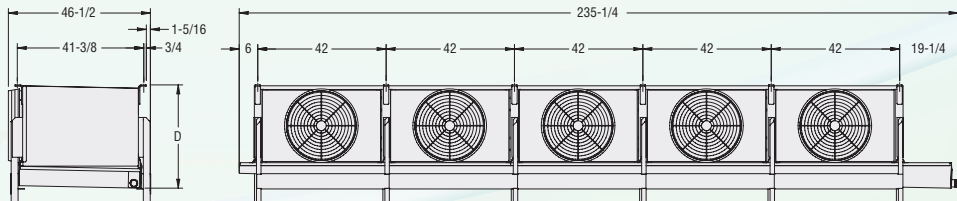

SSTSB Small to Medium Low-Charge Unit Coolers

NEW!

Our NEW Small to medium unit coolers featuring 3/8 inch stainless steel tube that offers a reduced refrigerant charge compared to similarly sized units with larger diameter tubes.

Capacity & Low-Charge in One:

- Optimized recirculation rate of 1.2:1
- Utilizing the 3/8 inch tube technology to get comparable capacities with less charge
- Smooth appearance with fewer breaks and seams
- Superior hygienic drain pan design pan design covers the entire casing and coil connection ensuring that all moisture is collected

The Easiest Evaporator to Clean, Maintain & Install:

- Hygienic cabinet design—all support angles and channels are turned inward
- Hinged fan panels allow easy access to fan motors, the air exit side of the coil, and the drain pan
- Drain pans are fully accessible with the wet coil baffles installed
- Wet coil baffles are installed in the middle of the coil to prevent air bypass and allow for drain pan access from both sides of the coil
- Ships with removable sheet metal channels for easy forklift handling—no shipping skids or crating disposal required

Standard:

- Heavy-wall, 0.375-inch diameter, stainless steel tubing featuring CROSSCOOL™ Enhanced Tube Technology
- Aluminum fin construction featuring CHANNELFLOW Fin Technology
- G-235 hot dip galvanized steel casing and dual-sloped drain pan
- Heavy-duty sheet metal fans

Options:

- One to five fan models
- Low sound fan motors ranging from 1/4 horsepower to 5 horsepower in 690, 870, 1160 and 1750 RPM.
- Cast aluminum fan blades for special low-temperature applications
- Ultra hygienic construction and EVAPCO Sanitary System (see page 26)
- See page 24 for custom options

AHRI Certified

In accordance with the AHRI Unit Cooler Certification Program Operations Manual (UCOM) the Thermal Performance and Rated Power (watts or horsepower) for each SSTSB evaporator has been determined and verified per Standard 420.



Shown with shipping and installation supports.

SSTSB Engineering Data

SSTSB Dimensional Data

SSTSB1

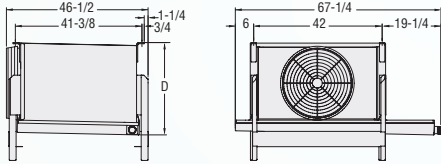

Model	*Tons	CFM	D Dimension
SSTSB1	1.1 - 8.4	2540 - 17100	30-1/4" - 54-1/4"
SSTSB2	2.1 - 16.9	5080 - 34200	31" - 55"
SSTSB3	3.2 - 25.5	7620 - 51290	31-7/8" - 55-7/8"
SSTSB4	4.3 - 33.0	10160 - 63890	32-3/4" - 56-3/4"
SSTSB5	5.4 - 42.5	12700 - 85490	33-5/8" - 57-5/8"

SSTSB2

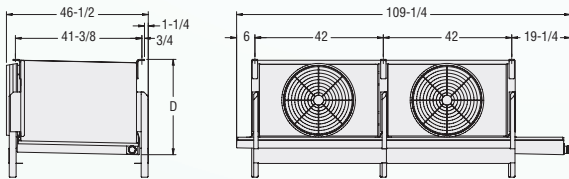

*Capacity is based on a dry coil rating with R-717 at 1.2 : 1.0 recirculation rate with 35°F entering air temperature and 25°F saturated suction temperature.

SSTSB3

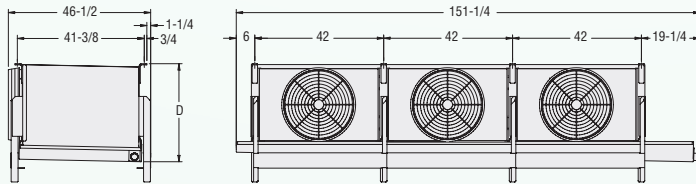

SSTSB4

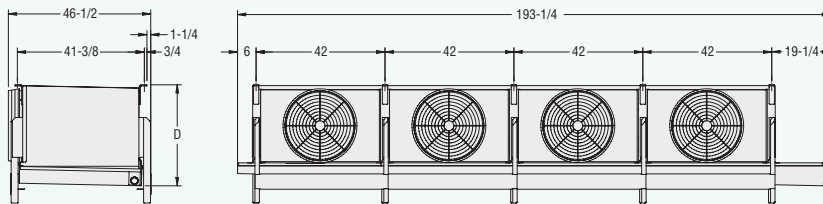

SSTSB5

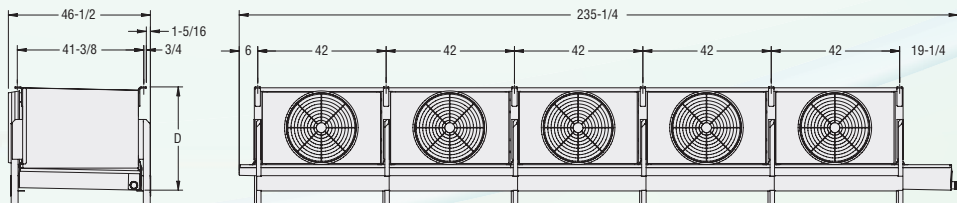

SSTXB Small & Medium Low-Profile Unit Coolers

When your project is faced with height limitations, EVAPCO has you covered. Our SSTXB gives you all the advantages of the SSTMB small and medium unit cooler, expertly designed into a low-profile package. It's the perfect solution for height-restricted freezers, coolers and docks that require low-medium-and high-temperature applications.

The Advantages of the SSTXB— Now in a Low-Profile Design:

- Optimized recirculation rate of 1.2:1 significantly reduces system refrigerant charge
- Smooth appearance with fewer breaks and seams
- Superior hygienic drain pan design covers the entire casing and coil connections, ensuring that all moisture is collected
- Hygienic cabinet design—all support angles and channels are turned inward
- Hinged fan panels allow easy access to fan motors, the air exit side of the coil, and the drain pan
- Drain pans are fully accessible with the wet coil baffles installed
- Wet coil baffles are installed in the middle of the coil to prevent air bypass and allow for drain pan access from both sides of the coil
- Ships with removable sheet metal channels for easy forklift handling—no shipping skids or crating disposal required

Standard:

- Heavy-wall, 0.625-inch diameter, stainless steel tubing featuring CROSSCOOL™ Enhanced Tube Technology
- Aluminum fin construction featuring CHANNELFLOW Fin Technology
- G-235 hot dip galvanized steel casing and dual-sloped drain pan
- Cast aluminum fan blades

Options:

- One to five fan models
- Low sound 1750 RPM fan motors ranging from 1/2 to 1 horsepower.
- See page 24 for all custom options

AHRI Certified

In accordance with the AHRI Unit Cooler Certification Program Operations Manual (UCOM) the Thermal Performance and Rated Power (watts or horsepower) for each SSTXB evaporator has been determined and verified per Standard 420.

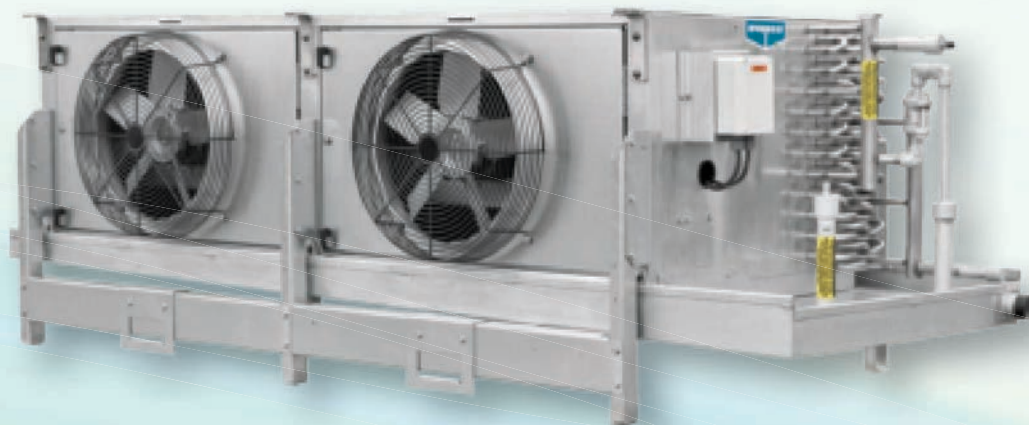

Shown with shipping and installation supports.

SSTXB Engineering Data

SSTXB Dimensional Data

SSTXB1

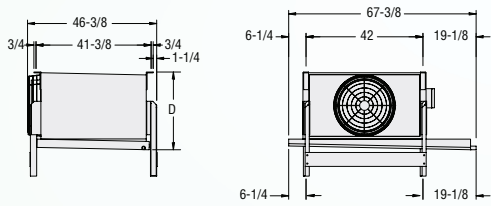

Model	*Tons	CFM	D Dimension
SSTXB1	1.4 - 3.4	2940 - 5190	28"
SSTXB2	2.7 - 6.8	5880 - 10370	28-7/8"
SSTXB3	4 - 10.2	8810 - 15560	29-3/4"
SSTXB4	5.4 - 13.6	11750 - 20740	30-5/8"
SSTXB5	6.8 - 17.0	14680 - 25930	32-1/8"

*Capacity is based on a dry coil rating with R-717 at 1.2 : 1.0 recirculation rate with 35°F entering air temperature and 25°F saturated suction temperature.

SSTXB2

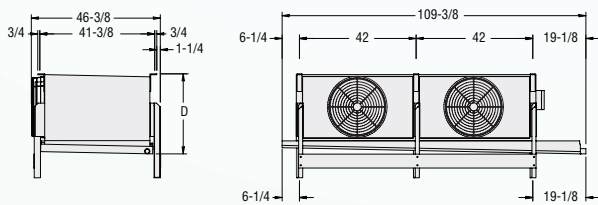

SSTXB3

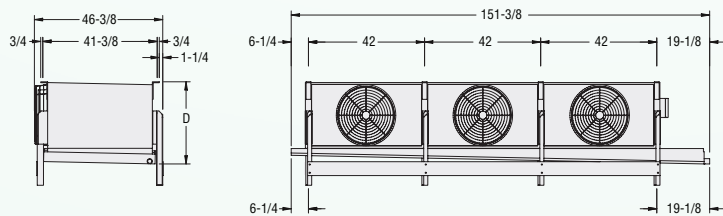

SSTXB4

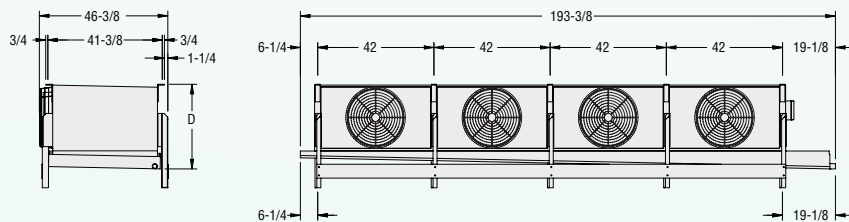

SSTXB5

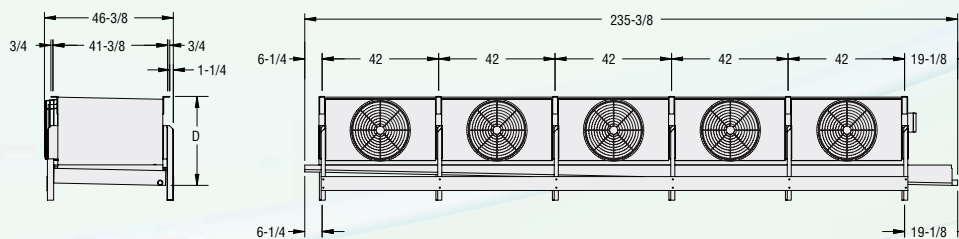

SSTEB Small to Medium Low-Profile/Charge Unit Coolers

NEW!

Our NEW Small to medium low profile unit coolers featuring 3/8 inch stainless steel tube that offers a reduced refrigerant charge compared to similarly sized units with larger diameter tubes.

Capacity & Low-Charge in One:

- Optimized recirculation rate of 1.2:1
- Utilizing the 3/8 inch tube technology to get comparable capacities with less charge
- Smooth appearance with fewer breaks and seams
- Superior hygienic drain pan design pan design covers the entire casing and coil connection ensuring that all moisture is collected

The Easiest Evaporator to Clean, Maintain & Install:

- Hygienic cabinet design—all support angles and channels are turned inward
- Hinged fan panels allow easy access to fan motors, the air exit side of the coil, and the drain pan
- Drain pans are fully accessible with the wet coil baffles installed
- Wet coil baffles are installed in the middle of the coil to prevent air bypass and allow for drain pan access from both sides of the coil
- Ships with removable sheet metal channels for easy forklift handling—no shipping skids or crating disposal required

Standard:

- Heavy-wall, 0.375-inch diameter, stainless steel tubing featuring CROSSCOOL™ Enhanced Tube Technology
- Aluminum fin construction featuring CHANNELFLOW Fin Technology
- G-235 hot dip galvanized steel casing and dual-sloped drain pan
- Cast aluminum fan blades

Options:

- One to five fan models
- Low sound 1750 RPM fan motors ranging from 1/2 to 1 horsepower.
- Ultra hygienic construction and EVAPCO Sanitary System (see page 26)
- See page 24 for custom options

AHRI Certified

In accordance with the AHRI Unit Cooler Certification Program Operations Manual (UCOM) the Thermal Performance and Rated Power (watts or horsepower) for each SSTMB evaporator has been determined and verified per Standard 420.



Shown with shipping and installation supports.

SSTEB Engineering Data

SSTEB Dimensional Data

SSTEB1

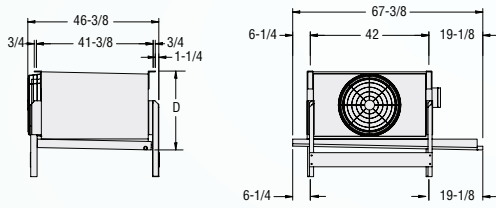

Model	*Tons	CFM	D Dimension
SSTEB1	1.1 - 3.3	3010 - 5300	28"
SSTEB2	2.1 - 6.7	6010 - 10610	28-7/8"
SSTEB3	3.2 - 10.1	9010 - 15910	29-3/4"
SSTEB4	4.3 - 13.3	12010 - 21210	30-5/8"
SSTEB5	5.4 - 16.8	15010 - 26510	32-1/8"

*Capacity is based on a dry coil rating with R-717 at 1.2 : 1.0 recirculation rate with 35°F entering air temperature and 25°F saturated suction temperature.

SSTEB2

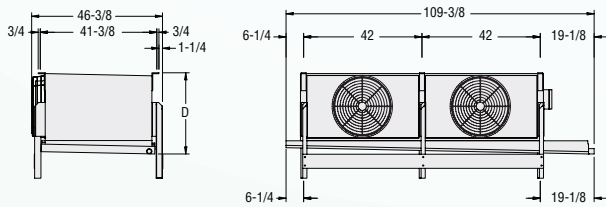

SSTEB3

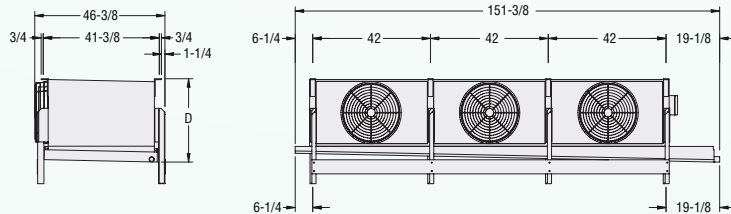

SSTEB4

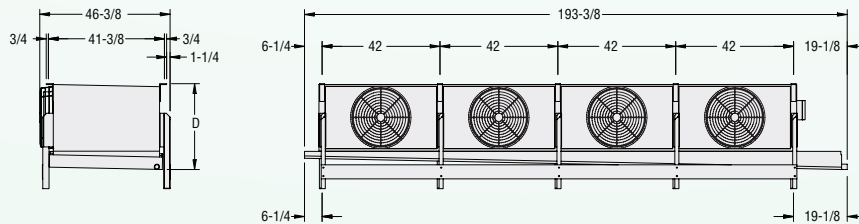

SSTEB5

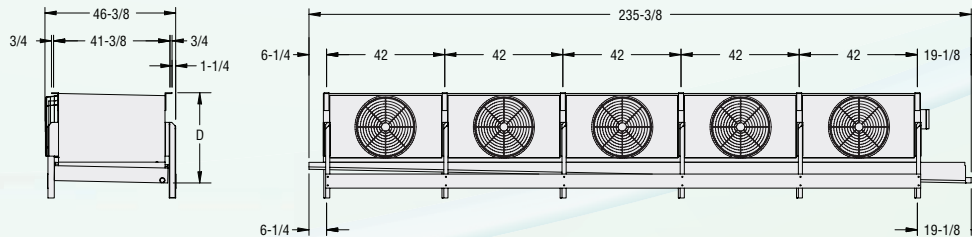

SSTLB Large Product Coolers

Discover the best value in large evaporators: the SSTLB. It combines high capacity with maintenance-friendly features to give you everything you need for your low and medium temperature freezer and cooler applications.

Capacity & Convenience in One:

- Optimized recirculation rate significantly reduces system refrigerant charge
- Clean cabinet design
- Hygienic drain pan design
- Removable structural channels and fork slots for easy forklift handling—no shipping skids or crating disposal required

Standard:

- Heavy-wall, 1.05-inch diameter, stainless steel tubing featuring CROSSCOOL™ Enhanced Tube Technology
- Aluminum fin construction featuring CHANNELFLOW Fin Technology
- G-235 hot dip galvanized steel casing
- G-235 hot dip galvanized steel dual-sloped drain pan
- Heavy-duty cast aluminum fans from 1-1/2 horsepower up to 7-1/2 horsepower in 870, 1160 and 1750 RPM motors
- Sloped top panels

Options:

- One to four fan models
- Type 304 stainless steel casing and drain pan
- Hinged fan panels
- See page 24 for custom options

AHRI Certified

In accordance with the AHRI Unit Cooler Certification Program Operations Manual (UCOM) the Thermal Performance and Rated Power (watts or horsepower) for each SSTLB evaporator has been determined and verified per Standard 420.



SSTLB Engineering Data

SSTLB Dimensional Data

SSTLB1

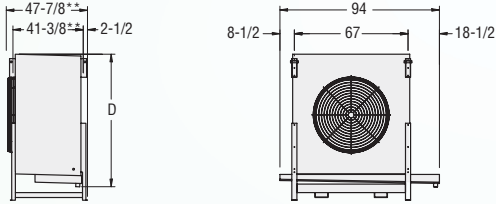

Model	*Tons	CFM	D Dimension
SSTLB1	6.4 - 16.2	11430 - 29570	60-1/8" - 84-1/8"
SSTLB2	12.7 - 32.0	22860 - 59140	61-1/2" - 85-1/2"
SSTLB3	18.8 - 48.2	34290 - 88710	62-7/8" - 86-7/8"
SSTLB4	24.9 - 64.1	45730 - 118280	64-3/8" - 88-3/8"

*Capacity is based on a dry coil rating with R-717 at 1.8 : 1.0 recirculation rate with 35°F entering air temperature and 25°F saturated suction temperature.

** Add 4-1/8" for 10 row deep models

SSTLB2

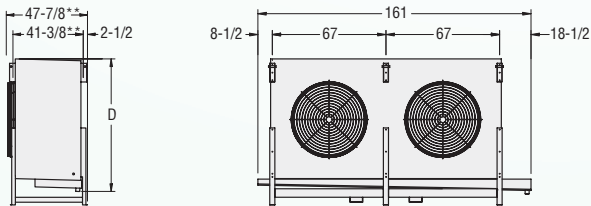

SSTLB3

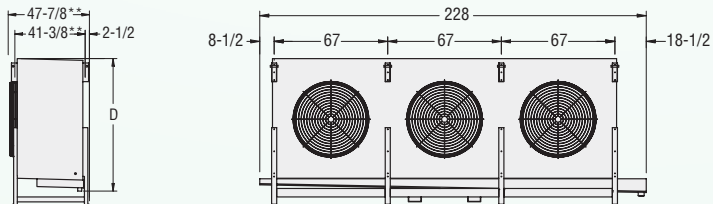

SSTLB4

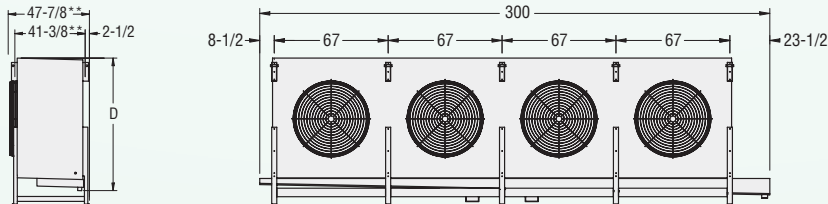

SSTHB Medium to Large Hybrid Cooler

Our hybrid cooler, the SSTHB, marries the best of both worlds—the heat transfer coil technology of the SSTMB with the product features of the SSTLB—to solve your low- and medium-temperature freezer and cooler challenges.

More Power, Less Waste:

- Larger capacity
- Lower refrigerant charge
- Lower cost per ton
- Small-diameter stainless steel tubes and large cabinet—ideal for CO₂ applications

Standard:

- Heavy-wall, 0.625-inch diameter, stainless steel tubing featuring CROSSCOOL™ Enhanced Tube Technology
- Aluminum fin construction featuring CHANNELFLOW Fin Technology
- G-235 hot dip galvanized steel casing
- G-235 hot dip galvanized steel dual-sloped drain pan
- Heavy-duty cast aluminum fans from 1-1/2 horsepower up to 7-1/2 horsepower in 870, 1160 and 1750 RPM motors
- Sloped top panels
- Clean cabinet design
- Removable structural channels and fork slots for easy forklift handling—no shipping skids or crating disposal required

Options:

- One to four fan models
- Type 304 stainless steel casing and drain pan
- Hinged fan panels
- See page 24 for custom options

AHRI Certified

In accordance with the AHRI Unit Cooler Certification Program Operations Manual (UCOM) the Thermal Performance and Rated Power (watts or horsepower) for each SSTHB evaporator has been determined and verified per Standard 420.



SSTHB Engineering Data

SSTHB Dimensional Data

SSTHB1

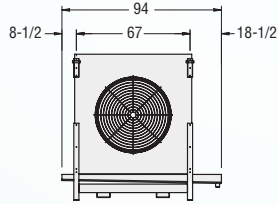
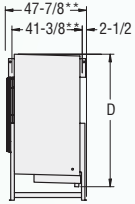

Model	*Tons	CFM	D Dimension
SSTHB1	7.1 - 19.1	11430 - 30610	60-1/8" - 84-1/8"
SSTHB2	14.1 - 38.3	22860 - 61220	61-1/2" - 85-1/2"
SSTHB3	21.1 - 57.5	34290 - 91840	62-7/8" - 86-7/8"
SSTHB4	28.3 - 77.6	45720 - 122450	64-3/8" - 88-3/8"

*Capacity is based on a dry coil rating with R-717 at 1.8 : 1.0 recirculation rate with 35°F entering air temperature and 25°F saturated suction temperature.

** Add 4-1/8" for 10 & 12 row deep models

SSTHB2

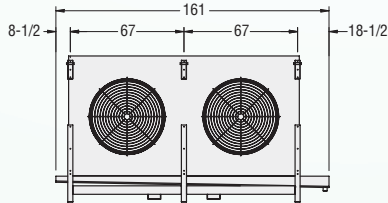
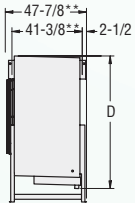

SSTHB3

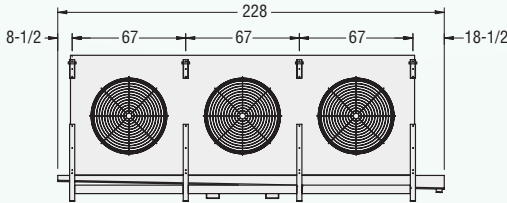
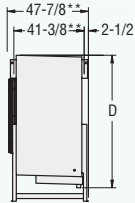

SSTHB4

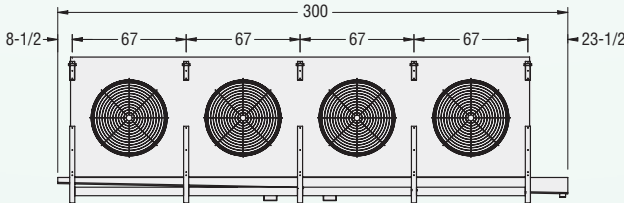
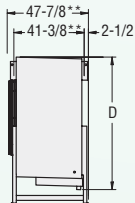

SSTWB Workroom Units

Designed for low-velocity/high-occupancy applications, such as processing rooms, the SSTWB maximizes working comfort while minimizing maintenance downtime.

Maximum Comfort Meets Minimal Maintenance:

- Optimized recirculation rate of 1.2:1 significantly reduces system refrigerant charge
- Hinged casing panels for fast, easy cleaning
- Low RPM fan motors for low air velocity and low sound
- Sloped top panels and full-coverage drain pans help prevent food contamination
- Drain pans are also fully accessible for easy maintenance without disassembly

Standard:

- Heavy-wall, 0.625-inch diameter, stainless steel tubing featuring CROSSCOOL™ Enhanced Tube Technology
- Aluminum fin construction featuring CHANNELFLOW Fin Technology
- Type 304 stainless steel casing panels, inner and outer drain pan, and fan motor base
- Foot-mounted fan motors pre-wired to a NEMA 4X

- junction box and equipped with automatic thermal overload protection (up to 1-1/2 horsepower)
- Easy access cabinet design (hinged side panels)
- Hygienic drain pan design
- G-235 hot dip galvanized, removable shipping and installation supports for easy forklift handling—no shipping skids or crating disposal required

Options:

- One to five fan models
- Reduced height models for low ceiling applications
- Fully welded Drain pans for increased hygiene
- See page 24 for custom options

The SSTWB evaporator falls outside the scope of the AHRI Unit Coolers Certification Program, but is rated in accordance with AHRI Standard 420.



SSTWB Engineering Data

SSTWB Dimensional Data

SSTWB1

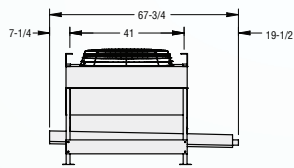
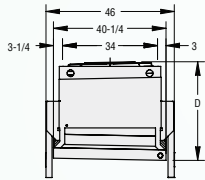

Model	*Tons	CFM	D Dimension
SSTWB1	1.9 - 4.4	3800 - 8250	35-3/8" - 44-7/8"
SSTWB2	3.8 - 8.8	7790 - 16500	35-3/8" - 44-7/8"
SSTWB3	5.7 - 13.2	11400 - 24740	35-3/8" - 44-7/8"
SSTWB4	7.6 - 17.7	15200 - 32990	35-3/8" - 44-7/8"
SSTWB5	9.5 - 21.9	19000 - 41240	35-3/8" - 44-7/8"

*Capacity is based on a dry coil rating with R-717 at 1.2 : 1.0 recirculation rate with 35°F entering air temperature and 25°F saturated suction temperature.

SSTWB2

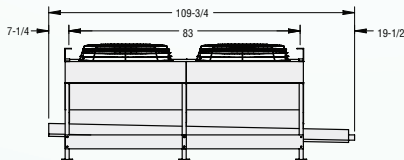
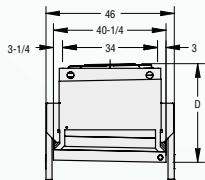

SSTWB3

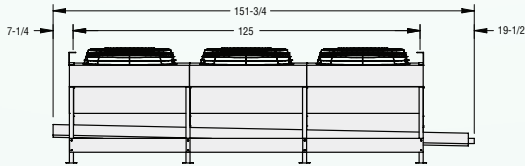
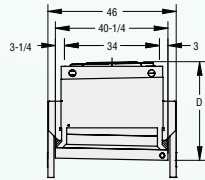

SSTWB4

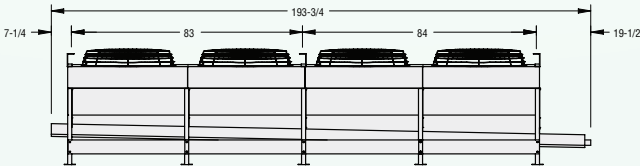
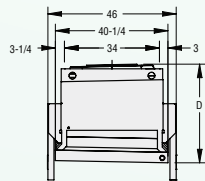

SSTWB5

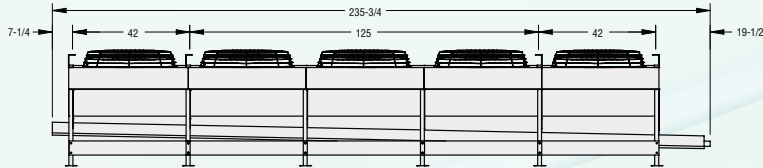
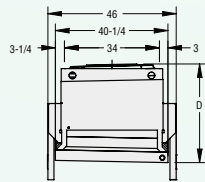

SSTDB Dual-Coil Low-Profile Unit Coolers

The SSTDB dual-coil, low-profile evaporator make it easy to overcome both height restrictions and dual-airflow challenges without sacrificing performance or convenience. Ideal for freezer and cooler applications.

Short on Height. Big on Performance and Convenience:

- Optimized recirculation rate of 1.2:1 significantly reduces system refrigerant charge
- Can be constructed for blow-through and draw-through configurations
- Hinged fan panels for quick access to the fan motors and plenum section, allowing easy interior maintenance and cleanup
- Saddle drain connection installed in the end of the drain pan to minimize piping height and ensure complete drainage
- Wet coil baffles installed in the middle of the coil for faster cleaning without disassembly
- Interconnecting piping between coils reduces the cost of installation

Standard:

- Heavy-wall, 0.625-inch diameter, stainless steel tubing featuring CROSSCOOL™ Enhanced Tube Technology
- Aluminum fin construction featuring CHANNELFLOW Fin Technology
- G-235 hot dip galvanized steel casing

- G-235 hot dip galvanized steel dual-sloped drain pan
- Heavy duty sheet metal fans
- Foot-mounted fan motors pre-wired to a NEMA 4X junction box and equipped with automatic thermal overload protection (up to 1-1/2 horsepower)
- Removable structural channels and fork slots for easy forklift handling—no shipping skids or crating disposal required

Options:

- One to five fan models
- Type 304 stainless steel casing panels and drain pans
- Cast aluminum fans for special low-temperature applications
- See page 24 for custom options

The SSTDB evaporator falls outside the scope of the AHRI Unit Coolers Certification Program, but is rated in accordance with AHRI Standard 420.



SSTDB Engineering Data

SSTDB Dimensional Data

SSTDB1

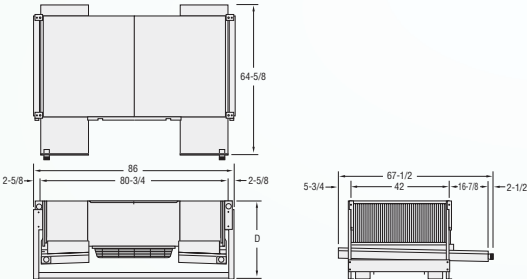

Model	*Tons	CFM	D Dimension
SSTDB1	2.6 - 5.4	8050 - 9970	24"
SSTDB2	5.1 - 10.7	8090 - 19940	24-7/8"
SSTDB3	7.7 - 15.9	12140 - 29910	25-3/4"
SSTDB4	10.2 - 21.2	16180 - 39870	26-5/8"
SSTDB5	14.3 - 26.6	20230 - 45380	27-1/2"

*Capacity is based on a dry coil rating with R-717 at 1.2 : 1.0 recirculation rate with 35°F entering air temperature and 25°F saturated suction temperature.

SSTDB2

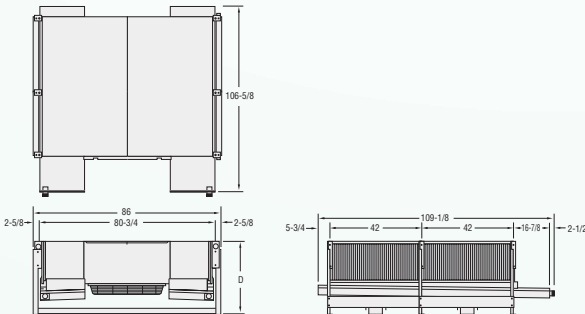

SSTDB3

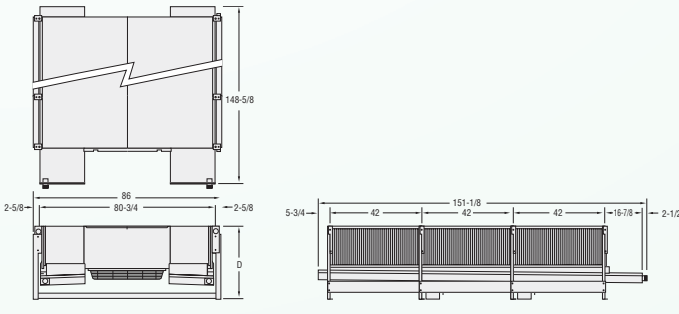

SSTDB4

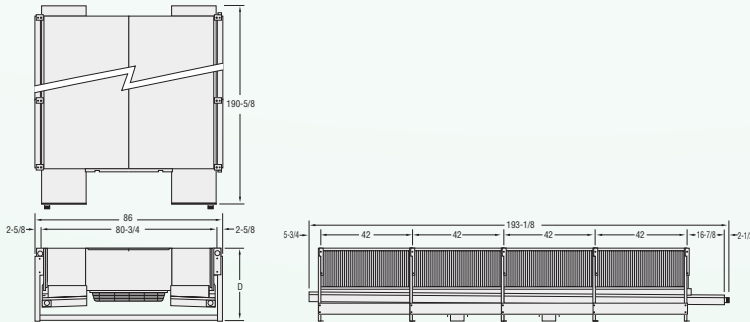

SSTDB5

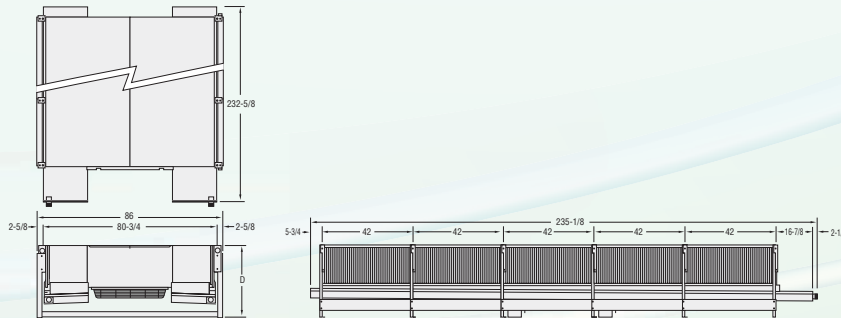

Optional Features for Every Application

Air Discharge Arrangements

- Long throw adapters for installations in large rooms or corridors
- 45° downblow configuration for layout flexibility
- 90° downblow configuration for penthouse applications
- Reversible fan push-pull arrangements for tempering or blast chill applications

NOTE: Air discharge options impact free delivery of air and are not certified under AHRI Standard 420.

Defrost

- Air defrost with insulated drain pan.
- Water defrost with water distribution system and special drain pan to prevent water splashover into refrigerated space.
- Hot gas, coil-only defrost with insulated drain pan OR hot gas coil and pan defrost with a hot gas coil under the inner drain pan. The unique design of the hot gas drain pan provides for highly efficient defrost. Hot gas defrost units may be piped with either parallel feed to coil and drain pan or series flow from drain pan to coil. Hot gas pan-to-coil piping includes a factory mounted check valve.
- Electric defrost featuring electric resistance heater elements with termination thermostat. Electric defrost options are sized based on room temperature. Electric pan heaters included for room temperatures below 32°F. Electric defrost can be supplied with optional heater contractor.



Series Flow Hot Gas Coil and Pan with Factory Mounted Check Valve



Terminal Strip

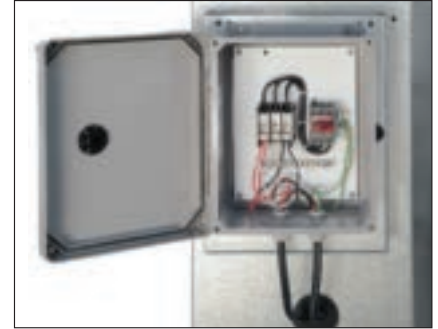

Common Non-Fused Disconnect

Electrical

Fan motors on SST-B Series evaporators are prewired to a terminal box as standard. Wiring on one- and two-fan models terminate with leads inside a NEMA 4x junction box. For models with three or more fan motors, a terminal strip is included to which the motor leads are wired. Other electrical options include:

- Prewired to terminal strip
- Prewired to a common non-fused disconnect
- Prewired to disconnect with thermal overload protection
- Prewired to magnetic motor starter with disconnect

Fan Motors

All SST-B Series evaporators are supplied with totally enclosed air over (TEAO), foot-mounted fan motors with sealed bearings and low-temperature grease. Standard motors are suitable for operation on a variable frequency drive and range from 1/4 horsepower fractional motors to 7.5 horsepower, and are suitable for 230/460-volt, 3-phase, 60-cycle applications. In addition, standard motors are across-the line start and operate at either 870, 1160 or 1750 RPM. All 870 RPM motors up to 1 horsepower, all 1160 RPM motors up to 1-1/2 horsepower and all motors up to 2 horsepower 1750 RPM are equipped with automatic thermal overload protection. Optional motors are available, including:

- Multi-speed fan motors to match equipment capacity to reduced heat load requirements
- Washdown-duty fan motors for applications requiring CIP or water clean-up cycles

NOTE: Models utilizing 690 RPM fan motors are NOT rated for variable frequency drive operation.

Optional Features for Every Application

Custom Coil Applications

EVAPCO offers a broad range of unit configurations along with engineering expertise and manufacturing capability to design and build virtually any type of non-cataloged custom coil or special unit. Simply contact your EVAPCO Representative to get started.

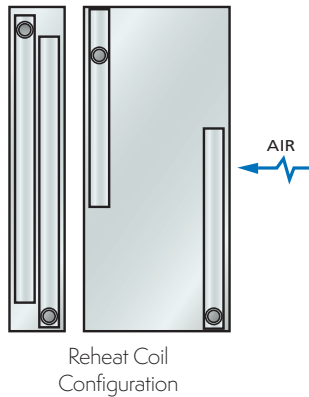

Coil Options

- Reheat coils for applications requiring humidity control. A separate heating coil is designed and circuited for refrigerant or an alternate heat source and is installed on the leaving air side of the cooling coil to heat the air to the desired temperature.
- Heavy fins constructed from 0.028-inch heavy gauge aluminum fins, making them 8 times stronger than standard thickness fins. Ideal for harsh environments and heavy frost applications.
- Pre-coated epoxy fins to provide additional resistance to corrosion.
- Stainless steel fins for highly corrosive applications.
- Canadian Registration Number (CRN) for Canadian applications.
- Variable fin spacing to extend cycles between defrost for applications where heavy frost loads are anticipated. Variable fin spacing is available in two-row increments.

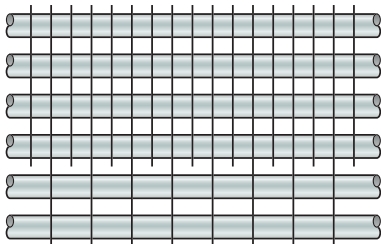

Variable Fin Spacing

Drain Pan Options

- Hot gas defrost drain pan featuring a unique tube design mechanically bonded to the underside of the pan liner and secured with a retaining plate. The hot gas coil design provides more heat transfer surface area and results in improved defrost performance with very low pressure drop. The construction features yield a completely flat, easy-to-clean interior pan surface.
- Stainless steel constructed drain pan
- Inner pan liner, outer pan cover, or both
- Heat tracing (inner pan liner/outer pan cover)
- Oversized drain pan fabricated to be wider and/or longer than standard

Hot Gas Drain Pan

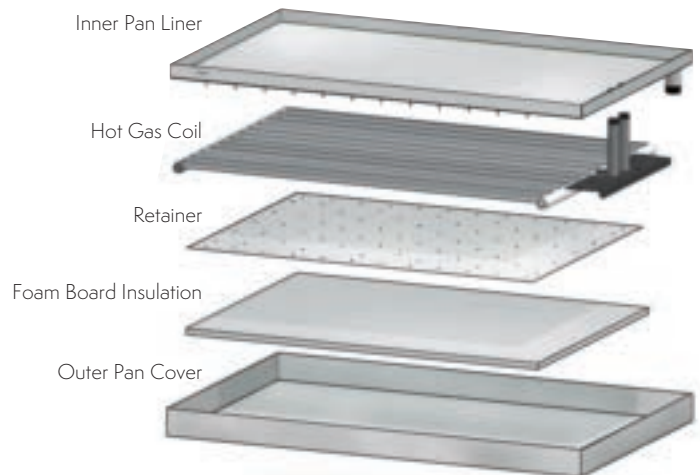

For selection and application assistance with our many design options, please contact your EVAPCO Representative. Find your Representative now at evapco.com.

More Options for Cleaner Technology

The SSTMB family of unit coolers by EVAPCO is the easiest evaporator to clean and maintain in the industry. But we couldn't stop there. We created multiple options to help you achieve the cleanest system you ever thought possible.

Ultra Hygienic Design

SSTMB evaporators can be equipped with optional ultra hygienic construction featuring an all-stainless-steel cabinet with fully welded drain pan and pan hangers. Unit hangers and motor bases are also fully welded and incorporate sanitary spaces to provide ease of cleaning and maintenance.

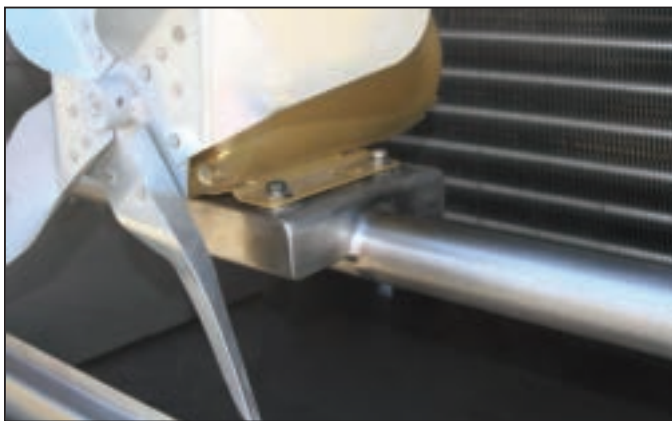

Fully Welded Stainless Pipe Motor Mount with "Spacer" Between the Motor and the Support for Complete Cleaning



Fully Welded Drain Pan with Rounded Corners

EVAPCO Sanitary System (ESS)

SSTMB evaporators can be equipped with the optional EVAPCO Sanitary System (ESS) featuring UVC Energy Technology. The ESS virtually eliminates hazardous bio-aerosols from the cooling coil and pan, resulting in hygienically clean air and improved product quality in your critical food processing areas.

- Provides full germicidal effect at low air temperatures
- Greater than seven times the effect of a standard UV bulb
- Destroys byproducts from mold and bacteria
- Lowers operating and maintenance costs by significantly reducing the need for cleaning equipment, solutions, and labor

The ESS option affects airflow and as such impacts thermal performance and AHRI rating parameters. Ask your EVAPCO representative for details.



Fully Welded Pan Hanger Brackets



Fully Welded Hanger Bracket

Suggested Mechanical Specifications

EVAPCO SST-B Series Evaporators

Furnish and install as shown on the plans SST-B Series evaporator having the capacity of ____ TR with NH3 at ____°F entering air temperature and ____°F evaporating temperature.

Method of Rating Capacity

The thermal capacity of the evaporator shall be based on "TD Ratings Method" as per AHRI-Standard 420. Temperature difference (TD) shall be defined as the value between the air temperature entering the coil air inlet and the saturated suction temperature (SST) at the outlet of the coil.

Casing

SSTMB, SSTSB, SSTLB, SSTHB, SSTXB, SSTE B and SSTDB models casing and drain pan shall be G-235 Hot Dip Galvanized Steel for long life.

SSTWB Evaporators

Casing, inner and outer drain pan shall be manufactured with Type 304 Stainless Steel panels. Motor base and all permanently installed panels shall be Type 304 Stainless Steel. The shipping supports are to be constructed from G-235 Hot Dip Galvanized Steel and should be removed after installation.

Fan Motor

Fan motors shall be totally enclosed air over design. Fan motor bearings shall be permanently lubricated with grease suitable for low ambient conditions. Fan motors shall be pre-wired to junction box.

Heat Transfer Coil

The heat exchanger coil shall be constructed from Type 304L Stainless Steel tubing and Aluminum fins. The stainless steel tubing meets the requirements of ASME B31.5 Refrigerant Piping Code. The tubing shall be roll formed, continuously welded and annealed. The welded tube is tested using an eddy current device. The round tubing is fit into the Aluminum fin plate and hydraulically expanded. The entire coil shall be pressure tested to 390 psig. The coil shall be evacuated and charged with low pressure Nitrogen prior to shipment.

Thermal Performance

SSTMB, SSTSB, SSTLB, SSTHB, SSTXB and SSTE B Models
Evaporator ratings (Gross Total Cooling Effect, Btu/h) shall be independently certified per the AHRI 420 Unit Cooler Certification Program with base models listed in the AHRI Directory at www.ahridirectory.org.

SSTWB and SSTDB Models

Evaporator ratings (Gross Total Cooling Effect, Btu/h) shall be rated in accordance with AHRI Standard 420.

Suggested Thermal Performance Guarantee Specification

Thermal Performance Guarantee

Product thermal rating and testing methods per AHRI Standard 420 shall be the basis for thermal performance guarantees. The units provided shall be guaranteed to provide the specified gross cooling effect (BTU/H) at the specified fan power, entering air conditions and suction temperature. If requested by AHRI for thermal performance evaluation, the equipment supplier shall provide an exact copy of the final approved equipment submittals to AHRI (for "AHRI eyes only"). The equipment submittal package shall provide the equipment technical specifications and guaranteed thermal performance conditions.

If a unit cooler manufacturer who participates in the AHRI unit cooler certification program ("Participating Manufacturer") initiates the product ratings challenge process contained in AHRI General Operations Manual Section 10.3 or 10.4, then the challenged supplier shall provide a duplicate unit for challenge testing upon request from AHRI (at the bid price). All costs and fees for challenge testing, including the cost of a duplicate unit for challenge testing in an AHRI certified laboratory, shall be borne by either the challenger (if the challenged unit passes the challenge test) or the equipment supplier (if the challenged unit fails the challenge test).

The challenged equipment manufacturer agrees to ship the

duplicate unit to a laboratory approved by AHRI for thermal performance testing in accordance with AHRI Standard 420. The challenge test shall be conducted according to the processes set forth in the AHRI General Operations Manual. If the unit passes the test, the Participating Manufacturer that issued the challenge shall reimburse AHRI for the costs of all testing. If the selected unit fails the test conducted at an AHRI 420 approved test laboratory, then in addition to any penalties or consequences set forth in the AHRI General Operations Manual, the challenged supplier shall:

1. Reimburse AHRI for the initial test and bear all expenses associated with providing the failing test unit.
2. Provide a new unit at no charge for AHRI 420 approved laboratory testing with modifications to assure a passing test result, but the modifications shall not increase the total fan energy requirement.
3. Continue to provide new units for testing at an AHRI approved test laboratory with modifications to assure a passing test result at no charge until a "pass" test result is achieved. The modifications shall not increase the total fan energy requirement and the challenged equipment supplier shall bear all expenses for AHRI certified laboratory testing until the test unit achieves a "pass" test result.
4. Modify all units provided for the project, or provide new units, in accordance with modifications required to achieve a "pass" test result for the challenged unit.



WORLDWIDE MANUFACTURING FACILITIES



- World Headquarters/ Research and Development Center
- EVAPCO Facilities

EVAPCO, Inc. — World Headquarters & Research / Development Center

P.O. Box 1300 • Westminster, MD 21158 USA
410-756-2600 p • 410-756-6450 f • marketing@evapco.com

North America

EVAPCO, Inc.
World Headquarters
P.O. Box 1300
Westminster, MD 21158 USA
410-756-2600 p | 410-756-6450 f
marketing@evapco.com

EVAPCO East
5151 Allendale Lane
Taneytown, MD 21787 USA
410-756-2600 p | 410-756-6450 f
marketing@evapco.com

EVAPCO Midwest
1723 York Road
Greenup, IL 62428 USA
217-923-3431 p | 217-923-3300 f
evapcomw@evapcomw.com

EVAPCO West
1900 West Almond Avenue
Madera, CA 93637 USA
559-673-2207 p | 559-673-2378 f
contact@evapcwest.com

EVAPCO Iowa
925 Quality Drive
Lake View, IA 51450 USA
712-657-3223 p | 712-657-3226 f

EVAPCO Iowa Sales & Engineering
215 1st Street, NE
P.O. Box 88
Medford, MN 55049 USA
507-446-8005 p | 507-446-8239 f
evapcomn@evapcomn.com

EVAPCO Newton
701 East Jourdan Street
Newton, IL 62448 USA
618-783-3433 p | 618-783-3499 f
evapcomw@evapcomw.com

EVAPCOLD
521 Evapco Drive
Greenup, IL 62428 USA
217-923-3431 p
evapcomw@evapcomw.com

EVAPCO-BLCT Dry Cooling, Inc.
1011 U.S. Highway 22 West
Bridgewater, NJ 08807 USA
1-908-379-2665 p
info@evapco-blct.com

Refrigeration Valves & Systems Corporation
A wholly owned subsidiary of EVAPCO, Inc.
1520 Crosswind Drive
Bryan, TX 77808 USA
979-778-0095 p | 979-778-0030 f
rsv@rvscorp.com

EVAPCO Northwest
5775 SW Jean Road, Suite 210
Lake Oswego, OR 97035 USA
503-639-2137 p | 503-639-1800 f

EvapTech, Inc.
A wholly owned subsidiary of EVAPCO, Inc.
8331 Nieman Road
Lenexa, KS 66214 USA
913-322-5165 p | 913-322-5166 f
marketing@evaptech.com

Tower Components, Inc.
A wholly owned subsidiary of EVAPCO, Inc.
5960 US Highway 64 East
Ramseur, NC 27316 USA
336-824-2102 p | 336-824-2190 f
mail@towercomponentsinc.com

South America

EVAPCO Brasil
Equipamentos Industriais Ltda.
Al. Vênus, 151 – CEP: 13347-659
Indaiatuba – São Paulo – Brasil
(55) 11-5681 2000 p
E-mail: vendas@evapco.com.br

Europe

EVAPCO Europe BVBA
European Headquarters
Industrieterrein Oost 4010
3700 Tongeren, Belgium
(32) 12-395029 p | (32) 12-238527 f
evapco.europe@evapco.be

EVAPCO Europe, S.r.l.
Via Ciro Menotti, 10
I-20017 Passirana di Rho
Milan, Italy
(39) 02-939-9041 p | (39) 02-935-00840 f
evapcoeuropa@evapco.it

EVAPCO Europe, S.r.l.
Via Dosso 2
23020 Piateda
Sondrio, Italy

EVAPCO Europe GmbH
Insterburger Straße 18
D-40670 Meerbusch, Germany
(49) 2159-69560 p | (49) 2159-695611 f
info@evapco.de

EVAPCO Air Solutions
A wholly owned subsidiary of EVAPCO, Inc.
Knøsgårdsvej 115
DK-9440 Aabybro, Denmark
(45) 9824 4999 p | (45) 9824 4990 f
info@flexcoil.dk

EVAPCO S.A. (Pty.) Ltd.
A licensed manufacturer of EVAPCO, Inc.
18 Quality Road
Isando 1600
Republic of South Africa
(27) 11-392-6630 p | (27) 11-392-6615 f
evapco@evapco.co.za

Evap Egypt Engineering Industries Co.
A licensed manufacturer of EVAPCO, Inc.
5 El Nasr Road
Nasr City, Cairo, Egypt
2 02 24022866 / 2 02 24044997 p
2 02 24044667 / 2 02 24044668 f
primacool@link.net / shady@primacool.net

Asia/Pacific

EVAPCO Asia/Pacific Headquarters
1159 Luoning Road, Baoshan Industrial Zone
Shanghai 200949, P.R. China
(86) 21-6687-7786 p | (86) 21-6687-7008 f
marketing@evapcochina.com

EVAPCO (Shanghai) Refrigeration Equipment Co., Ltd.
1159 Luoning Rd., Baoshan Industrial Zone
Shanghai 200949, P.R. China
(86) 21-6687-7786 p | (86) 21-6687-7008 f
marketing@evapcochina.com

Beijing EVAPCO Refrigeration Equipment Co., Ltd.
No. 13 Yanxi Avenue, Yanqi Development Zone
Huai Rou County
Beijing, P.R. China Postal Code: 101407
Beijing, P.R. China Postcode: 101407
010-6166-7238 p | 010-6166-7295 f
evapcobj@evapcochina.com

EVAPCO Australia (Pty.) Ltd.
34-42 Melbourne Road
P.O. Box 436
Riverstone NSW 2765, Australia
(61) 2 9627-3322 p | (61) 2 9627-1715 f
sales@evapco.com.au

EVAPCO Composites Sdn. Bhd
No. 70 (Lot 1289) Jalan Industri 2/3
Rawang Integrated Industrial Park
48000 Rawang, Selangor, Malaysia
60 3 6092-2209 p | 60 3 6092-2210 f

EvapTech Asia Pacific Sdn. Bhd
A wholly owned subsidiary of EvapTech, Inc.
B-61, IOI Boulevard
Jalan Kenari 5, Bandar Puchong Jaya
47170 Puchong, Selangor, Malaysia
(60-3) 8070-7255 p | (60-3) 8070-5731 f
marketing-ap@evaptech.com





WORLDWIDE MANUFACTURING FACILITIES



- World Headquarters/ Research and Development Center
- EVAPCO Facilities

EVAPCO, Inc. — World Headquarters & Research / Development Center

P.O. Box 1300 • Westminster, MD 21158 USA
410-756-2600 p • 410-756-6450 f • marketing@evapco.com

North America

EVAPCO, Inc.
World Headquarters
P.O. Box 1300
Westminster, MD 21158 USA
410-756-2600 p | 410-756-6450 f
marketing@evapco.com

EVAPCO East
5151 Allendale Lane
Taneytown, MD 21787 USA
410-756-2600 p | 410-756-6450 f
marketing@evapco.com

EVAPCO Midwest
1723 York Road
Greenup, IL 62428 USA
217-923-3431 p | 217-923-3300 f
evapcomw@evapcomw.com

EVAPCO West
1900 West Almond Avenue
Madera, CA 93637 USA
559-673-2207 p | 559-673-2378 f
contact@evapcowest.com

EVAPCO Iowa
925 Quality Drive
Lake View, IA 51450 USA
712-657-3223 p | 712-657-3226 f

EVAPCO Iowa Sales & Engineering
215 1st Street, NE
P.O. Box 88
Medford, MN 55049 USA
507-446-8005 p | 507-446-8239 f
evapcomn@evapcomn.com

EVAPCO Newton
701 East Jourdan Street
Newton, IL 62448 USA
618-783-3433 p | 618-783-3499 f
evapcomw@evapcomw.com

EVAPCOLD
521 Evapco Drive
Greenup, IL 62428 USA
217-923-3431 p
evapcomw@evapcomw.com

EVAPCO-BLCT Dry Cooling, Inc.
1011 U.S. Highway 22 West
Bridgewater, NJ 08807 USA
1-908-379-2665 p
info@evapco-blct.com

Refrigeration Valves & Systems Corporation
A wholly owned subsidiary of EVAPCO, Inc.
1520 Crosswind Drive
Bryan, TX 77808 USA
979-778-0095 p | 979-778-0030 f
rsv@rvscorp.com

EVAPCO Northwest
5775 SW Jean Road, Suite 210
Lake Oswego, OR 97035 USA
503-639-2137 p | 503-639-1800 f

EvapTech, Inc.
A wholly owned subsidiary of EVAPCO, Inc.
8331 Nieman Road
Lenexa, KS 66214 USA
913-322-5165 p | 913-322-5166 f
marketing@evaptech.com

Tower Components, Inc.
A wholly owned subsidiary of EVAPCO, Inc.
5960 US Highway 64 East
Ramseur, NC 27316 USA
336-824-2102 p | 336-824-2190 f
mail@towercomponentsinc.com

South America

EVAPCO Brasil
Equipamentos Industriais Ltda.
Al. Vênus, 151 – CEP: 13347-659
Indaiatuba – São Paulo – Brasil
(55) 11-5681 2000 p
E-mail: vendas@evapco.com.br

Europe

EVAPCO Europe BVBA
European Headquarters
Industrieterrein Oost 4010
3700 Tongeren, Belgium
(32) 12-395029 p | (32) 12-238527 f
evapco.europe@evapco.be

EVAPCO Europe, S.r.l.
Via Ciro Menotti, 10
I-20017 Passirana di Rho
Milan, Italy
(39) 02-939-9041 p | (39) 02-935-00840 f
evapcoeuropa@evapco.it

EVAPCO Europe, S.r.l.
Via Dosso 2
23020 Piateda
Sondrio, Italy

EVAPCO Europe GmbH
Insterburger Straße 18
D-40670 Meerbusch, Germany
(49) 2159-69560 p | (49) 2159-695611 f
info@evapco.de

EVAPCO Air Solutions
A wholly owned subsidiary of EVAPCO, Inc.
Knøsgårdsvej 115
DK-9440 Aabybro, Denmark
(45) 9824 4999 p | (45) 9824 4990 f
info@flexcoil.dk

EVAPCO S.A. (Pty.) Ltd.
A licensed manufacturer of EVAPCO, Inc.
18 Quality Road
Isando 1600
Republic of South Africa
(27) 11-392-6630 p | (27) 11-392-6615 f
evapco@evapco.co.za

Evap Egypt Engineering Industries Co.
A licensed manufacturer of EVAPCO, Inc.
5 El Nasr Road
Nasr City, Cairo, Egypt
2 02 24022866 / 2 02 24044997 p
2 02 24044667 / 2 02 24044668 f
primacool@link.net / shady@primacool.net

Asia/Pacific

EVAPCO Asia/Pacific Headquarters
1159 Luoning Road, Baoshan Industrial Zone
Shanghai 200949, P.R. China
(86) 21-6687-7786 p | (86) 21-6687-7008 f
marketing@evapcochina.com

EVAPCO (Shanghai) Refrigeration Equipment Co., Ltd.
1159 Luoning Rd., Baoshan Industrial Zone
Shanghai 200949, P.R. China
(86) 21-6687-7786 p | (86) 21-6687-7008 f
marketing@evapcochina.com

Beijing EVAPCO Refrigeration Equipment Co., Ltd.
No. 13 Yanxi Avenue, Yanqi Development Zone
Huai Rou County
Beijing, P.R. China Postal Code: 101407
Beijing, P.R. China Postcode: 101407
010-6166-7238 p | 010-6166-7295 f
evapcobj@evapcochina.com

EVAPCO Australia (Pty.) Ltd.
34-42 Melbourne Road
P.O. Box 436
Riverstone NSW 2765, Australia
(61) 2 9627-3322 p | (61) 2 9627-1715 f
sales@evapco.com.au

EVAPCO Composites Sdn. Bhd
No. 70 (Lot 1289) Jalan Industri 2/3
Rawang Integrated Industrial Park
48000 Rawang, Selangor, Malaysia
60 3 6092-2209 p | 60 3 6092-2210 f

EvapTech Asia Pacific Sdn. Bhd
A wholly owned subsidiary of EvapTech, Inc.
B-61, IOI Boulevard
Jalan Kenari 5, Bandar Puchong Jaya
47170 Puchong, Selangor, Malaysia
(60-3) 8070-7255 p | (60-3) 8070-5731 f
marketing-ap@evaptech.com

