



LRC

EVAPORATIVE CONDENSERS



FORCED DRAFT, COUNTERFLOW EVAPORATIVE CONDENSERS
Thermal Performance from 156 to 6673 kW Nominal Capacity

RESEARCH POWERED SOLUTIONS!

CERTIFIED EN ISO 9001



LRC



Since its founding in 1976, EVAPCO, Inc. has become a world-wide leader in supplying quality cooling equipment for thousands of customers in both the commercial and industrial markets.

EVAPCO's success has been the result of a continual commitment to product improvement, quality workmanship and a dedication to providing unparalleled service.



Our emphasis on research and development has led to many product innovations – a hallmark of EVAPCO through the years.

The ongoing R & D Program enables EVAPCO to provide the most advanced products in the industry – technology for the future, available today.

EVAPCO products are manufactured on five continents around the world and distributed through hundreds of factory authorized sales representatives.

The LRC units are a result of EVAPCO's extensive experience in forced draft centrifugal fan designs. They are designed for easy maintenance and long, trouble free operation. These units are also designed with IBC Compliant construction. All features shown are available on all models.

Z-725 Heavy Mill Galvanized Steel Construction

(Stainless steel available as an affordable option)

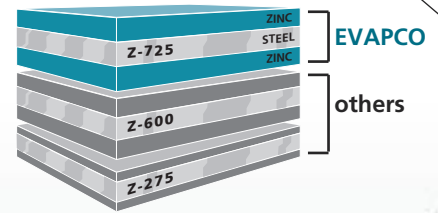

Thermal Pak® II Heat Transfer Technology

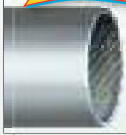
- Features EVAPCO's **NEW** exclusive **CROSSCOOL™** tube enhancement for greater internal heat transfer 
- More surface area per plan area than competitive designs
- Improved heat transfer efficiency due to tube geometry and orientation of tubes
- Lower refrigerant charge
- Optional Stainless Steel Coil technology

Totally Enclosed Fan Motors & Superior Drive System

- Assures long life
- Located in dry, incoming air-stream, allowing normal maintenance to be done from the outside of the unit
- If required, motor can be easily removed
- Solid fan shaft
- Belt tensioning and bearing lubrication can be performed from outside the unit
- Motor is fully accessible by removing one inlet screen

Stainless Steel Strainer

- Resists corrosion better than other materials

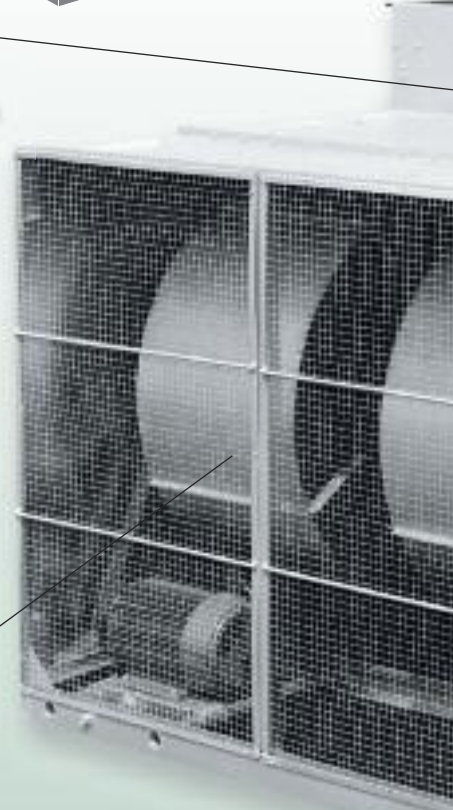

DESIGN AND CONSTRUCTION FEATURES



IBC Compliant Design
 Refer to page 11 for details

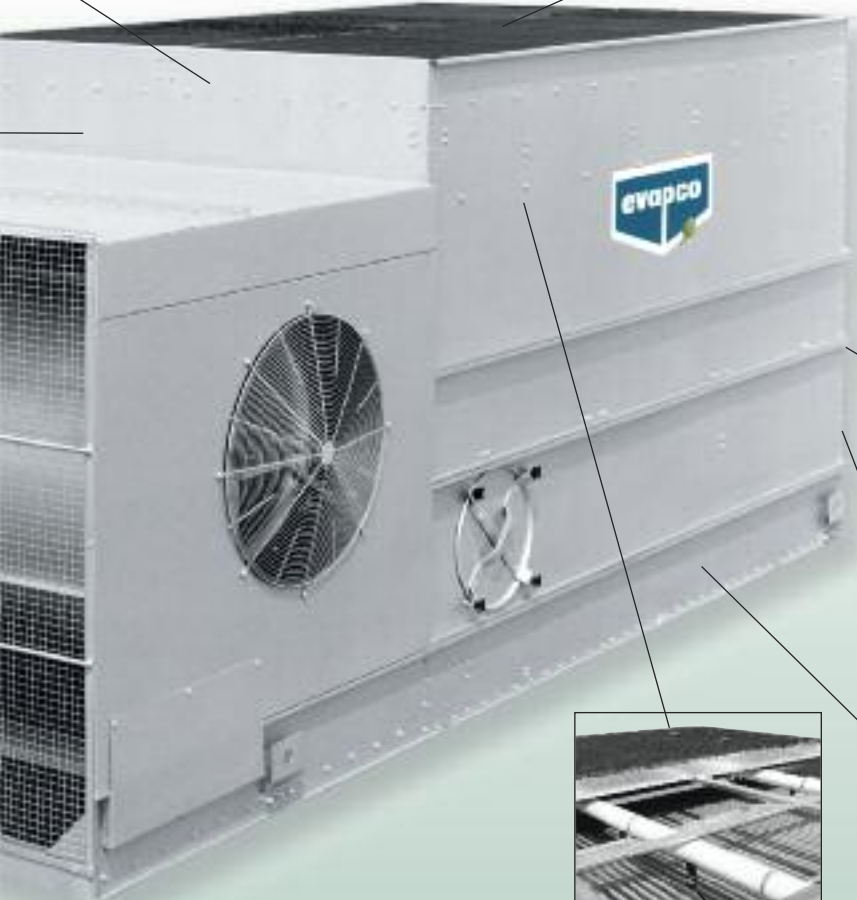

Water Saver Drift Eliminators

- New patented design reduces drift rate to < 0.001%
- Saves water and reduces water treatment cost
- Greater structural integrity vs. old style blade-type
- Recessed into casing for greater protection
- Drift rate certifications Eurovent OM-14-2009



Double-Brake Flange Joints

- Stronger than singlebrake designs by others
- Increases field rigging joint integrity
- Greater structural integrity

Totally Enclosed Pump Motors

- Help assure long, trouble-free operation

Stainless Steel Cold Water Basin

- Eliminates the need for unreliable epoxy coatings

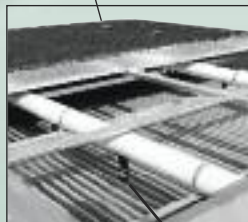

PVC Spray Distribution Header with ZM® II Nozzles

- Large orifice nozzles prevent clogging (no moving parts)
- Redesigned nozzles for superior water distribution
- Nozzles are threaded into header at proper orientation
- Fixed position nozzles require zero maintenance



Contractor Features

- Low Rigging Cost
- Low Installation Cost

Owner Features

- Low Profile (low height)
- Low Maintenance

Engineering Features

- Lowest Sound with Full Attenuation
- IBC Compliant Design

LRC

DESIGN FEATURES

EVAPCOAT:

Z-725 Hot-Dip Galvanized Steel Construction

The Z-725 Mill Hot-Dip Galvanized Steel Construction is the heaviest level of galvanizing available for

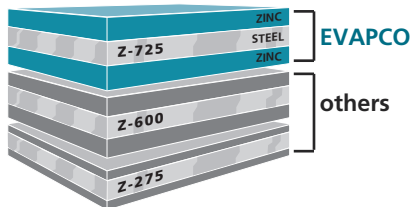

manufacturing evaporative cooling towers and has more zinc protection than competitive designs using Z-275 and Z-600 steel.

EVAPCO has been a leader in the industry in developing heavier galvanizing, and was the first to standardize on Z-725 mill hot-dip galvanized steel. Z-725 designation means there is a minimum of 725g of zinc per m² of surface area present on the steel. During fabrication, all panel edges are coated with a 95% pure zinc-rich compound for extended corrosion resistance.

The EVAPCOAT Corrosion Protection System is the heaviest galvanized coating available for extended corrosion protection eliminating the need for costly, unreliable epoxy paint finishes.

In addition, the LRC comes standard with an SST 304L cold water basin.

Stainless Steel Material Options

The EVAPCOAT Corrosion Protection System is satisfactory for most applications. If additional corrosion protection is required the following stainless steel options are available (AISI 304 and 316). Please contact your local EVAPCO representative for pricing.

Type 304 Stainless Steel Strainers

Subjected to excessive wear and corrosion, the sump strainer is critical to the successful operation of the condenser. EVAPCO uses only stainless steel for this very important component.

Thermal-Pak® II Coil

EVAPCO'S Thermal-Pak® II condensing coils are designed for maximum heat transfer efficiency. This unique coil design utilizes counterflow heat transfer. The rows of elliptical tubes are staggered and angled in the direction of airflow to enhance air turbulence, thereby increasing heat transfer while minimizing airside pressure drop.

The design features of EVAPCO's Thermal-Pak® II condensing coils ensure the end user will receive the best evaporative heat transfer efficiency.

These characteristics and other engineering advancements of the Thermal-Pak® II have been proven in EVAPCO's world-class research and development laboratory resulting in the following end user benefits:

- Lower Operating Refrigerant Charge
- Low Power Consumption Per kW
- Lower Operating Weight
- Small Plan Area Per kW

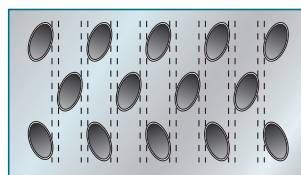

Thermal-Pak® II Coil by EVAPCO

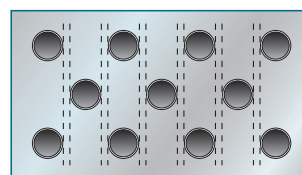

Round Tube Coil by Others

The coils are manufactured from high quality internally enhanced **CROSSCOOL™** carbon steel tubing following the most stringent quality control procedures. Each circuit is inspected to assure the material quality and then tested before being assembled into a coil. Finally, the assembled coil is tested at 35,5 bar air pressure under water to make sure it is leak free.

To protect the coil against corrosion, it is placed in a heavy-duty steel frame and the entire assembly is dipped in molten zinc (hot dip galvanized) at a temperature of approximately 430°C.

ZM® II Spray Nozzle Water Distribution System

Even and constant water distribution is paramount for reliable, scale-free evaporative condensing. EVAPCO's Zero Maintenance ZM® II Spray Nozzle remains clog-free under the toughest conditions to deliver approximately 14 m³/h to every square meter of coil plan area.

The heavy-duty ABS ZM® II Spray Nozzles have a 32 mm diameter opening and a 32 mm splash plate clearance. The fixed position ZM® II Spray Nozzles are mounted in corrosion-free PVC water distribution pipes. Together, these elements combine to provide unequalled coil coverage, enhanced droplet formation and make the industries best performing maintenance-free water distribution system.



ZM® II nozzle

LRC

DESIGN FEATURES

Reduced Height and Improved Maintenance Accessibility

The LRC unit has been designed to satisfy installation requirements where height limits must be observed. The lower profile design of the LRC does not, however, sacrifice maintenance accessibility for reduced height. Its unique casing design allows the water distribution system, cold water basin, fan section and other unit components to be easily maintained. Small, light weight sections of the drift eliminators can be easily removed to access the water distribution system. Large circular access doors are located on both sides of the cold water basin to allow adjustment of the float assembly, removal of the stainless steel strainers and cleaning of the basin. The fan motor and drive system are located at one end of the unit and are completely accessible by removing the inlet screens. Although, routine maintenance can be performed from the exterior of the unit without removing the inlet screens.

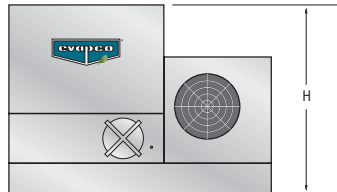

Cold Water Basin Access

The LRC cold water basin can be easily maintained from the sides of the cooling tower through large, circular access doors. The unique stepped configuration of the LRC heat transfer section allows unimpeded access to the basin to allow adjustment of the float assembly, removal of the stainless steel strainers and basin cleaning.



Mechanical Drive System Access

The LRC mechanical drive system is easy to maintain. Bearing lubrication and belt adjustment can be performed from outside the unit. There is no need to remove fan screens to maintain important



drive components. In addition, the locking mechanism used to maintain belt tension can also work as a wrench to adjust the belt.

Motor Location

All LRC models have TEFC motors mounted on adjustable motor bases, similar in design to the large EVAPCO ATC-E Condenser Drive System. This same technology has been utilized in the LRC design to allow belt adjustment to be performed externally. In addition, the motor is located under the protective fan system enclosure and can be easily accessed by removing one air inlet screen.

Fan Access-Split Housing

Another unique feature of the LRC Condensers are split fan housings. The split fan housing on the LRC allows quick removal of the fans from the front end of the unit. This feature allows fan removal when units are placed side by side where space is minimal.

Transport of a Pre-Assembled Unit

The LRC ships fully assembled. This means lower transport costs and no further expenses at the job site for assembly. LRC units are ideal for truck-mounted applications for remote sites or temporary installations.

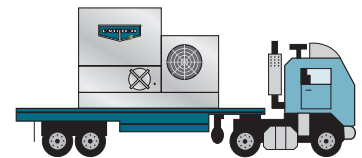

Efficient Drift Eliminators*

An extremely efficient drift eliminator system is standard on the LRC Condenser. The system removes entrained water droplets from the air stream to limit the drift rate to less than 0.001% of the recirculating water rate. With a low drift rate, the LRC Condenser saves valuable water and water treatment chemicals. The LRC can be located in areas where minimum water carryover is critical, such as parking lots. The drift eliminators are constructed of an inert polyvinyl chloride (PVC) plastic material which effectively eliminates corrosion of these vital components. They are assembled in sections to facilitate easy removal for inspection of the water distribution system. EVAPCO can provide the Eurovent drift rate certificate in accordance with OM-14-2009.

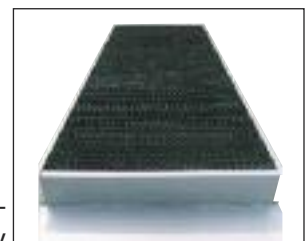

* US Patent No. 6315804B1

LRC

DESIGN FEATURES

Principle of Operation

The refrigerant gas is discharged from the compressor into the inlet connection of the evaporative condenser. Water from the condenser's sump is continuously distributed over the condenser coil, while ambient air is simultaneously forced into the unit. As the ambient air moves up through the coil section, a portion of the spray water is evaporated into the air stream.

The evaporative process cools the spray water, which in turn cools the tubes containing the refrigerant gas. The cool tube walls cause the refrigerant gas to give up heat and condense into a liquid. The condensed liquid flows out of the coil's sloping tubes to the high pressure liquid receiver for return to the system.

The hot saturated air is driven through the drift eliminators, where any entrained water droplets are removed. The condenser's fan then discharges this air stream out of the top of the unit at a high velocity, where it can dissipate harmlessly into the atmosphere. The water which was not evaporated falls into the sump and is recirculated by the spray pump to the water distribution system above the condensing coil section.

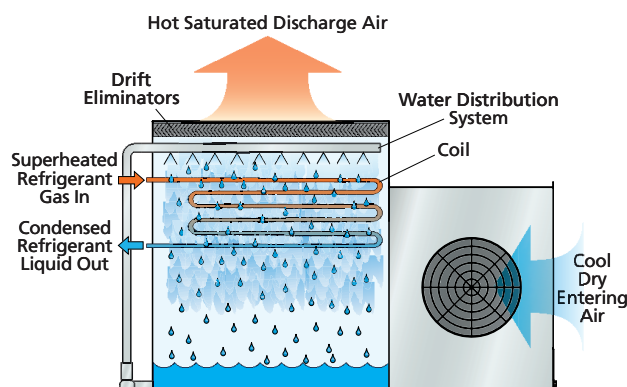

Unit selection

With the **evapSelect™** program, equipment selections, written specifications, unit drawing files and EVAPCO on-line information are readily available from the comfort of your own office!

evapSelect™ is a Web based computer selection program which allows the design engineer to choose EVAPCO models and optimize unit selections. The program allows the engineer to evaluate the equipment's thermal performance, space and energy requirements. Once the model is selected and optional equipment features are inserted, the engineer may output a complete specification **AND** a unit drawing from this program. The software is designed to provide the user with maximum flexibility in analyzing the various selection parameters.

The **evapSelect™** software is available to all consulting engineering offices and contractors after contacting your local EVAPCO sales representative.

LRC

OPTIONAL EQUIPMENT

Pan Freeze Protection

Remote Sump

Whenever a condenser is idle during sub-freezing weather, the water in the sump must be protected from freezing and damaging the pan. The simplest and most reliable method of accomplishing this is with a remote sump tank located in a heated space in the building under the condenser. With this system, the water in the unit drains to the indoor tank whenever the pump is shut-off. When a condenser is ordered for remote sump operation, the standard circulating pump, float valve and strainer are omitted, and the unit is provided with an oversized water outlet connection. When a remote sump is not possible, a supplementary means of heating the pan water must be provided.

Electric Heaters

Electric immersion heaters are available factory installed in the basin of the condenser. They are sized to maintain a +5°C pan water temperature at 18°C ambient with the fans off. They are furnished with a combination thermostat/low water protection device to cycle the heater on when required and to prevent the heater elements from energizing unless they are completely submerged. All components are enclosed in rugged, weather proof enclosures for outdoor use. Heater control packages are available as an option. Contact your local EVAPCO representative for further details.

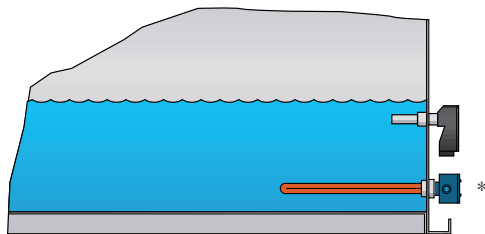

BASIN HEATER

*See factory certified prints for detailed drawings.

Electric Pan Heaters

Model No.	KW
LRC 25 to 72	(1) 2
LRC 76 to 114	(1) 3
LRC 108 to 183	(1) 3
LRC 190 to 246	(1) (6)
LRC 188 to 269	(1) (7)
LRC 249 to 379	(1) (9)

* Electric heater selection based on -18°C ambient temperature. For alternate low ambient heater selections, consult the factory.

Electric Water Level Control

EVAPCO LRC Condensers are available with an optional electric water level control system in place of the standard mechanical makeup valve and float assembly. This package provides accurate control of the pan water level and does not require field adjustment, even under widely variable operating conditions.

The control was designed by EVAPCO and consists of multiple heavy duty stainless steel electrodes. These electrodes are mounted external to the unit in a vertical stand pipe. For winter operation, the stand pipe must be wrapped with electric heating cable and insulated to protect it from freezing.

The weather protected slow closing solenoid valve for the makeup water connection is factory supplied and is ready for piping to a water supply with a pressure between 140 (minimum) and 350 kPa (maximum).

Vibration Isolators

The fans on EVAPCO condensers are balanced and run virtually vibration free. In addition, the rotating mass is very small in relation to the total mass of the condenser, further reducing the possibility of objectionable vibration being transmitted to the building structure. As a result, vibration isolation is generally not required.

In those cases where it is determined that vibration isolation is necessary, spring type vibration isolator rails can be furnished. The rails are constructed of heavy gauge Z-725 hot-dip galvanized steel for superior corrosion resistance. Rails are designed to be mounted between the condenser and the supporting steel framework. They are 90% efficient and have approximately 25 mm static deflection. Rails are designed for wind loading up to 80 km/h.

It is important to note that vibration isolation must be installed continuously along the full length of the condenser on both sides of the unit. Point isolators may be used between the supporting steel and the building framework, but not between the unit and the supporting steel.

IBC Certification cannot be given when vibration isolators are installed.

Other Options Available:

- Pony Motors
- Stainless Steel Material Options
- Tapered Discharge Hoods
- Low Sound Solutions

LRC

APPLICATIONS

LRC Ships Factory Assembled

The compact, unitary design of the LRC Condenser allows them to be shipped completely assembled. This results in lower transportation costs and no assembly requirements at the job site. Only one lift is required to rig the LRC.

Note: Options such as attenuation and discharge hoods will require additional lifts.

Structural Steel Support

The recommended method of support for the LRC condenser is two structural "I" beams located under the outer flanges and running the entire length of the unit. Mounting holes 19 mm in diameter, are located at the bottom channels of the pan section to provide for bolting to the structural steel. Refer to certified drawings from the factory for bolt hole locations. See the drawing and chart below for unit dimensions.

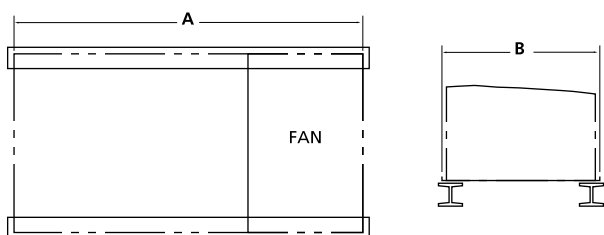

Model No.	Dimensions (mm)		
	A (unit only)	A (with atten.)	B
LRC 25 to 72	3096	4206	1029
LRC 76 to 114	3727	4842	1540
LRC 108 to 183	4629	5740	1540
LRC 190 to 246	5553	6664	1540
LRC 188 to 269	4629	5740	2388
LRC 249 to 379	5553	6664	2388

Note:

- 1) Beams should be level before setting the unit in place.
- 2) Do not level the unit by shimming between it and the "I" beams as this will not provide proper longitudinal support.
- 3) Beams should be sized in accordance with accepted structural practices. Support beams and anchor bolts are to be furnished by others.

Indoor Installation

All LRC Condensers can be installed indoors where they normally require ductwork to and from the unit. The design of the ductwork should be symmetrical to provide even air distribution across both intake and discharge openings. Guidelines for Ducted Applications:

- 1) The static pressure loss imposed by the ductwork must not exceed 120 Pa. The fan motor size must be increased for ESP up to 120 Pa.

- 2) For ducted installations, the solid bottom panel option must be ordered. A blank off plate will also be provided in lieu of the side air inlet screens with this option.
- 3) Important, Access Doors must be located in the ductwork for service to the fan drive components and water distribution system.

Drawings are available showing recommended ductwork connections. See EVAPCO's Layout Guidelines for additional information.

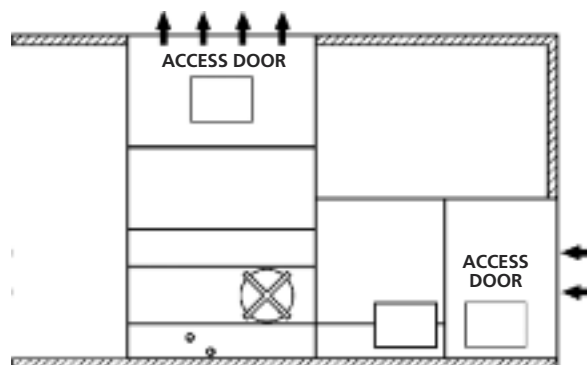

Design

EVAPCO LRC Condensers have heavy-duty construction and are designed for long, trouble-free operation. However, proper equipment selection, installation and maintenance are necessary to insure good unit performance. Some of the major considerations in the application of a condenser are presented below. For additional information, contact the factory.

Air Circulation

In reviewing the system design and unit location, it is important that enough fresh air is provided to enable proper unit performance. The best location is on an unobstructed roof top or on ground level away from walls and other barriers. Care must be taken when locating condensers in wells or enclosures or next to high walls. The potential for recirculation of the hot, moist discharge air back into the fan intake exists. Recirculation raises the wet bulb temperature of the entering air causing the leaving water temperature to rise above design. For these cases, a discharge hood or ductwork should be provided to raise the overall unit height even with the adjacent wall, thereby reducing the chance of recirculation. For additional information see the EVAPCO Equipment Layout Manual. Engineering assistance is also available from the factory to identify potential recirculation problems and recommend solutions.

APPLICATIONS

LRC

Capacity Control

The design wet bulb for which the condenser is sized occurs only a small percentage of the time. Unless colder water temperatures are beneficial to the process being cooled, some form of capacity control will be needed.

A common control practice is to cycle the fans off when leaving water is below the minimum allowable temperature. However this does not provide close control of the leaving water temperature and may cycle the motor on and off more than the recommended limit of six (6) starts per hour.

Another method is to use two-speed fan motors which add a second step of control. Two speed fan motors are an excellent method of capacity control for the LRC. This arrangement gives capacity steps of 10% (fans off), 60% (fans half-speed) and 100%. A temperature controller can be supplied to set control at 3°C increments, so fairly close temperature control can be maintained without excessive cycling of the fan motor.

Two-speed motors also save operating costs. At half-speed the motor draws approximately 15% of full load power. Since maximum wet bulb and maximum load very seldom coincide on air conditioning systems, the condenser will actually operate at half speed 80% of the time. Thus, power costs will be reduced by approximately 85% during the major portion of the operating season.

Caution: The water circulation pump must be interlocked with the fan motor starter(s) to insure water flow over the condenser fill during fan operation.

Piping

Condenser piping should be designed and installed in accordance with generally accepted engineering practices. All piping should be anchored by properly designed hangers and supports with allowance made for possible expansion and contraction. No external loads should be placed upon condenser coil connections, nor should any of the pipe supports be anchored to the unit framework.

Maintaining the Recirculated Water System

The condensing in a condenser is accomplished by the evaporation of a portion of the recirculated spray water. As this water evaporates, it leaves behind all of its mineral content and impurities. Therefore, it is important to bleed-off an amount of water equal to that which is evaporated to prevent the buildup of impurities. If this is not done, the mineral content and/or the corrosive nature of the water will continue to increase. This will ultimately result in heavy scaling or a corrosive condition.

Bleed-off

A bleed line should be installed in the piping, external to the unit. The bleed line must be properly sized for the application and provided with a metering connection and globe valve. The recommended bleed off for a condenser is equivalent to the evaporation rate of 1,58 l/h per kW of cooling. If the make-up water supplying the unit is relatively free of impurities, it may be possible to cut back the bleed, but the unit must be checked frequently to make sure scale is not forming. Make-up water pressure must be maintained between 140 and 340 kPa for proper operation of the float valve.

Water Treatment

In some cases the make-up water will be so high in mineral content that a normal bleed-off will not prevent scaling. In these cases water treatment will be required and a reputable water treatment company familiar with the local water conditions should be consulted.

Any chemical water treatment used must be compatible with the stainless and galvanized construction of the unit. The pH of the water should be maintained between 7.0 and 8.8. In order to prevent "white rust", the galvanized steel in the unit requires routine passivation of the steel when the system is operating in higher pH levels. Batch chemical feeding is not recommended because it does not afford the proper degree of control. If acid cleaning is required extreme caution must be exercised and only inhibited acids compatible with galvanized steel construction should be used.

Control of Biological Contamination

Water quality should be checked regularly for biological contamination. If biological contamination is detected, a more aggressive water treatment and mechanical cleaning program should be undertaken. The water treatment program should be performed by a qualified water treatment company and in accordance with relevant local legislation. It is important that all internal surfaces be kept clean of accumulated dirt and sludge. In addition, the drift eliminators should be maintained in good operating condition.

Note: The location of the condenser must be considered during the equipment layout stages of a project. It is important to prevent the discharge air (potential of biological contamination) from being introduced into the fresh air intakes of the building.

LRC

Notes:

LRC



The LRC Condenser is now available with sound attenuators to reduce the overall sound generated from the side or top of the Condenser.

Each option provides various levels of sound reduction and can be used in combination to provide the lowest sound level.

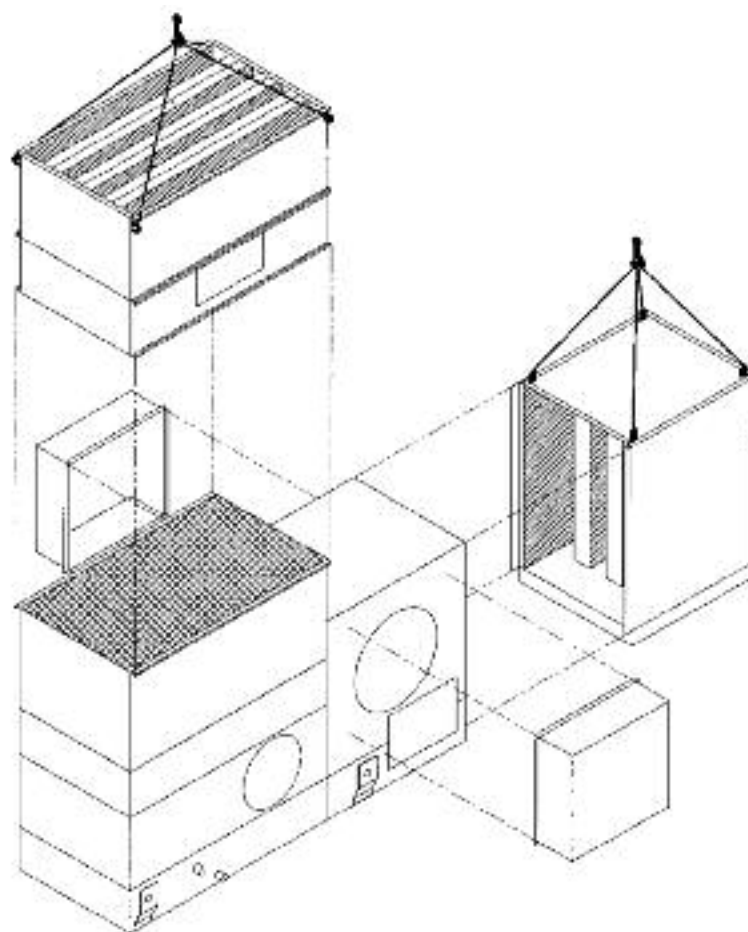

Condenser attenuation

LRC

DISCHARGE & INTAKE ATTENUATION DIMENSIONS

Sound Attenuation

The standard LRC is the quietest, low profile centrifugal fan condenser in the industry. This is achieved by providing the first stage of inlet sound attenuation as part of the LRC's standard design. The LRC drive system, including the fan housing(s), electric motors, belts, bearings and drives, is completely enclosed by a

protective housing which covers the drive system and also provides a significant level of sound reduction. If the standard LRC sound pressure level is not quiet enough for certain applications, the sound levels can be further reduced by adding various stages of sound attenuation. Consult the factory for Factory Certified Sound Data for each option.

LRC Discharge Attenuation Dimensions*

Model Name	H1 (mm)	L1 (mm)	W1 (mm)	Weight per attenuat. (kg)	Number of attenuators
LRC 25 to 72	1102	1822	1029	195	1
LRC 76 to 114	1102	1822	1540	240	1
LRC 108 to 183	1102	2724	1540	327	1
LRC 190 to 246	1102	3648	1540	417	1
LRC 188 to 269	1102	2724	2388	440	1
LRC 249 to 379	1102	3648	2388	558	1

LRC Intake Attenuation Dimensions*

Model Name	H2 (mm)	L2 (mm)	W2 (mm)	Weight per attenuat. (kg)	Number of attenuators
LRC 25 to 72	1622	1029	1108	204	1
LRC 76 to 114	2022	1540	1105	313	1
LRC 108 to 183	2022	1540	1105	313	1
LRC 190 to 246	2022	1540	1105	313	1
LRC 188 to 269	2022	2394	1108	417	1
LRC 249 to 379	2022	2394	1108	417	1

LRC Fan Side Attenuation Dimensions*

Model Name	H3 (mm)	L3 (mm)	W3 (mm)	Weight per Attenuat. (kg)	Number of Attenuators
LRC 25 to 72	854	1645	883	68	2
LRC 76 to 114	936	2155	1372	104	2
LRC 108 to 183	936	2155	1372	104	2
LRC 190 to 246	936	2155	1372	104	2
LRC 188 to 269	1075	3010	1121	104	2
LRC 249 to 379	1075	3010	1121	104	2

*Attenuation dimensions may vary slightly from catalog. See factory certified prints for exact dimensions.

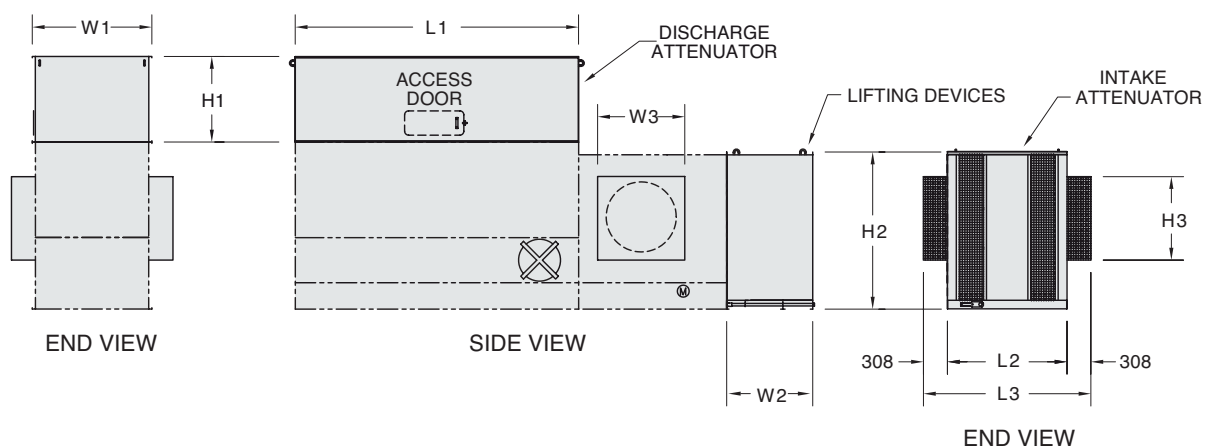

LRC Attenuation

LRC



The International Building Code (IBC) is a comprehensive set of regulations addressing the structural design and installation requirements for building systems – including HVAC and industrial refrigeration equipment.

With the advent of the IBC, EVAPCO is proud to introduce the LRC Condenser with IBC 2012 compliance standard.



We Stand Tall Through it All!

Wind, Rain, Earthquake and Hurricane

EVAPCO Condenser... designed to withstand seismic or wind load forces.

LRC

IBC COMPLIANCE

In its continuing commitment to be the leaders in evaporative cooling equipment design and services, EVAPCO LRC Condensers are now **Independently Certified** to withstand Seismic and Wind Loads in accordance with IBC 2012.

What is IBC?

International Building Code

The International Building Code (IBC) is a comprehensive set of regulations addressing both the structural design and the installation requirements for building systems – including HVAC and industrial refrigeration equipment. Compared to previous building codes that considered only the building structure and component anchorage, the requirements contained within the IBC address anchorage, structural integrity, and the operational capability of a component following either a seismic or wind load event. **Simply stated, the IBC code provisions require that evaporative cooling equipment, and all other components permanently installed on a structure, must be designed to meet the same seismic or wind load forces as the building to which they are attached.**

How Does IBC 2012 Apply to Condensers?

Based on site design factors, calculations are made to determine the equivalent seismic “g force” and wind load (kilo-Newton per square meter, kN/m²) on the unit. The condenser must be designed to withstand the greater of either the seismic or wind load. All locations with design criteria resulting in a seismic design force of up to 1.0g or a wind load of 2,87 kN/m² or below will be provided with the standard LRC structural design. An upgraded structural design is available for installations with design criteria resulting in “g forces” greater than 1.0g. The highest “g force” location in North America is 5.12g. The highest wind load shown on the maps is 273 km/h, which is approximately equal to 6,94 kN/m² velocity pressure. **Therefore, the upgraded structural design package option for the LRC is designed for 5.12 g and 6,94 kN/m² making it applicable to ALL building locations in North America.**

Design Implementation

EVAPCO applies the seismic design and wind load information provided for the project to determine the equipment design necessary to meet IBC requirements. This process ensures that the mechanical equipment and its components are compliant per the provisions of the IBC as given in the plans and specifications for the project.

Independent Certification

Although the IBC references and is based on the structural building code ASCE 7, many chapters and paragraphs of ASCE 7 are superseded by the IBC, independent certification and methods of analysis are such paragraphs. Per the most recent edition of the code, the EVAPCO compliance process included an exhaustive analysis by an independent approval agency. As required by the International Building Code, EVAPCO supplies a certificate of

compliance as part of its submittal documents. The certificate of compliance demonstrates that the equipment has been independently tested and analyzed in accordance with the IBC seismic and wind load requirements. Evapco has worked closely with the independent approval agency, The VMC Group, to complete the independent equipment testing and analysis.

For further questions regarding IBC compliance, please contact your local EVAPCO Representative.



LRC

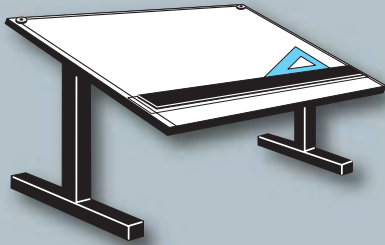

Engineering Data & Dimensions

LRC

ENGINEERING DATA AND DIMENSIONS

Models LRC 25 to 246

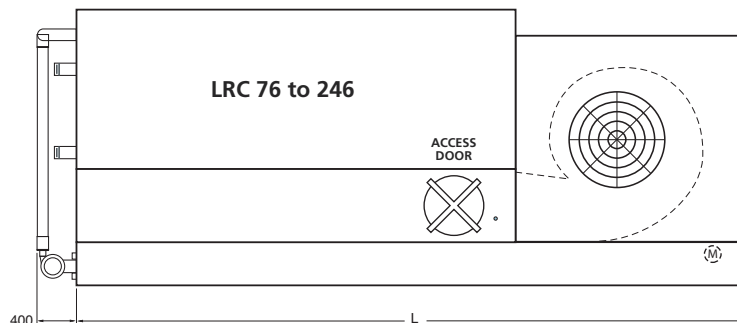
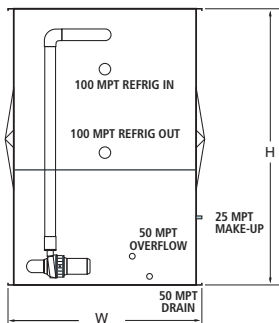
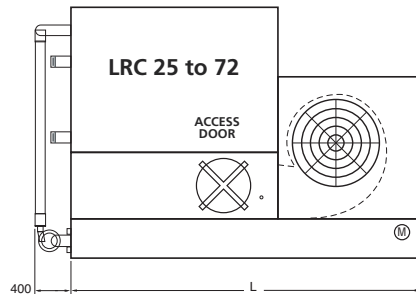
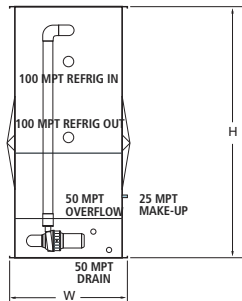

Unit No.	Fans			Weights (kg)		** R-717	Spray Pump kW	Remote Sump		Dimensions (mm)		
	N°	kW*	m³/s	Shipping	Operating	Operating Charge (kg)		Liters Req'd***	Conn. Size	Height H	Length L	Width W
LRC- 25	1	0,75	3,1	1050	1520	19	0,37	303	100	2026	3083	1029
27	1	1,1	3,6	1050	1525	19	0,37	303	100	2026	3083	1029
29	1	1,5	3,9	1050	1525	19	0,37	303	100	2026	3083	1029
35	1	1,1	3,5	1200	1685	27	0,37	303	100	2026	3083	1029
38	1	1,5	3,9	1200	1685	27	0,37	303	100	2026	3083	1029
42	1	2,2	4,4	1205	1690	27	0,37	303	100	2026	3083	1029
48	1	4	5,2	1210	1695	27	0,37	303	100	2026	3083	1029
51	1	2,2	4,3	1365	1860	34	0,37	303	100	2216	3083	1029
58	1	4	5,1	1370	1865	34	0,37	303	100	2216	3083	1029
65	1	4	5,0	1540	2050	42	0,37	303	100	2407	3083	1029
72	1	5,5	5,8	1565	2070	42	0,37	303	100	2407	3083	1029
LRC-76	1	4	7,6	1835	2680	43	0,75	455	150	2026	3731	1540
84	1	5,5	8,7	1850	2700	43	0,75	455	150	2026	3731	1540
91	1	4	7,4	2075	2945	55	0,75	455	150	2216	3731	1540
101	1	5,5	8,5	2120	2985	55	0,75	455	150	2216	3731	1540
114	1	5,5	8,3	2365	3250	67	0,75	455	150	2407	3731	1540
LRC-108	1	5,5	10,6	2380	3660	61	1,1	643	150	2026	4636	1540
116	1	7,5	11,7	2400	3675	61	1,1	643	150	2026	4636	1540
128	1	11	13,3	2450	3725	61	1,1	643	150	2026	4636	1540
131	1	5,5	10,4	2760	4065	79	1,1	643	150	2216	4636	1540
140	1	7,5	11,4	2770	4080	79	1,1	643	150	2216	4636	1540
155	1	11	13,1	2820	4130	79	1,1	643	150	2216	4636	1540
174	1	11	12,8	3215	4550	99	1,1	643	150	2407	4636	1540
183	1	11	12,6	3555	4920	118	1,1	643	150	2597	4636	1540
LRC-190	1	15	16,2	3465	5250	106	1,5	908	200	2242	5553	1540
201	1	18,5	17,4	3470	5255	106	1,5	908	200	2242	5553	1540
213	1	15	15,8	3955	5780	132	1,5	908	200	2432	5553	1540
225	1	18,5	17,0	3965	5785	132	1,5	908	200	2432	5553	1540
233	1	22	18,1	3975	5790	132	1,5	908	200	2432	5553	1540
246	1	22	17,7	4430	6295	157	1,5	908	200	2623	5553	1540

* For dry operation or for external static pressure up to 125 Pa use next larger size fan motor.

** Refrigerant charge is shown for R-717. Multiply by 1.93 for R22, 1.98 for R134A and 1.7 for R404A, R410A and R507A.

***Liters shown is water in suspension in unit and piping. Allow for additional water in bottom of remote sump to cover pump suction and strainer during operation. (300 mm would normally be sufficient.)

ENGINEERING DATA AND DIMENSIONS



Models LRC 188 to 379

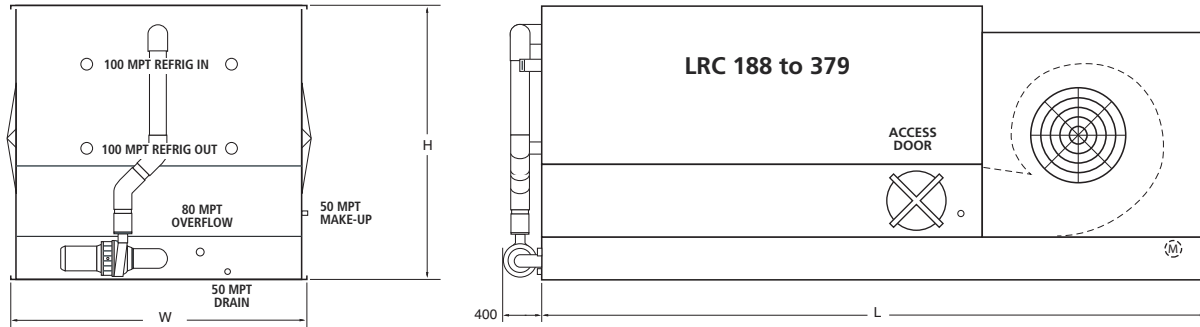

ENGINEERING

Unit No.	Fans			Weights (kg)		**R-717 Operating Charge (kg)	Spray Pump kW	Remote Sump		Dimensions (mm)		
	N°	kW*	m³/s	Shipping	Operating			Liters Req'd***	Conn. Size	Height H	Length L	Width W
LRC-188	2	15	19,7	3680	5780	94	1,5	946	200	2121	4629	2388
211	2	11	17,6	4225	6370	119	1,5	946	200	2311	4629	2388
227	2	15	19,3	4230	6380	119	1,5	946	200	2311	4629	2388
240	2	18,5	20,8	4235	6380	119	1,5	946	200	2311	4629	2388
255	2	15	19,0	4920	7165	178	1,5	946	200	2502	4629	2388
269	2	18,5	20,4	4925	7170	178	1,5	946	200	2502	4629	2388
LRC-249	2	22	26,3	4410	7265	128	2,2	1363	250	2121	5553	2388
287	2	18,5	24,3	5110	8035	166	2,2	1363	250	2311	5553	2388
300	2	22	25,9	5125	8040	166	2,2	1363	250	2311	5553	2388
321	2	18,5	23,8	5865	8845	204	2,2	1363	250	2502	5553	2388
336	2	22	25,3	5875	8855	204	2,2	1363	250	2502	5553	2388
361	2	30	27,9	6010	8985	204	2,2	1363	250	2502	5553	2388
379	2	30	27,3	6715	9750	242	2,2	1363	250	2692	5553	2388

* For dry operation or for external static pressure up to 125 Pa use next larger size fan motor.

** Refrigerant charge is shown for R-717. Multiply by 1.93 for R22, 1.98 for R134A and 1.7 for R404A, R410A and R507A.

***Liters shown is water in suspension in unit and piping. Allow for additional water in bottom of remote sump to cover pump suction and strainer during operation. (300 mm would normally be sufficient.)

LRC

SPECIFICATIONS

1.0 FORCED DRAFT EVAPORATIVE CONDENSER

1.1 General

Furnish and install factory assembled evaporative condenser of blow through, counterflow design with a horizontal single air side entry and a vertical air discharge. The unit shall be completely factory assembled and be conform to the specifications and schedules.

The condenser shall reject _____ kW of heat with _____ as refrigerant and _____ °C condensation temperature at a wet bulb temperature of _____ °C.

The total fan power should not exceed _____ kW and the total overall unit dimensions should not exceed the following :

- Length: mm
- Width: mm
- Height: mm

The unit will be delivered in one part.

Approved manufacturer: Evapco – model LRC _____

1.2 Thermal Performance – Performance Warranty

The condenser shall be capable of performing the thermal duties as shown in the schedule and on drawings, and its design thermal rating shall be guaranteed by the manufacturer.

1.3 Applicable Standards

CTI ATC 128 Test Code for Measurement of Sound from Water Cooling Towers.

1.4 Submittals

- a) The manufacturer shall submit a five year history of the proposed type of evaporative condenser with a minimum of 10 installations for similar sized equipment.
- b) Shop drawings: submit shop drawings indicating dimensions, weight loadings and required clearances.
- c) Product data: submit manufacturer’s technical product data, original selection printouts and clearance requirements.
- d) Complete noise data sheet for the selected evaporative condenser.
- e) Maintenance data for the evaporative condenser and accessories.
- f) The evaporative condenser manufacturer shall provide factory test run certificates of the fans and fan motor.

1.5 Product Delivery – Storage and Handling

- a) The contractor shall make the provisions for proper storage at site before installation and handle the product per the instructions of the manufacturer.
- b) Once installed provide the necessary measures that the units remain clean and protected from any dust and mechanical damage.

1.6 Quality Assurance

- a) The manufacturer shall have a quality assurance system in place which is certified by an accredited registrar and complying with the requirements of ISO 9001:2008. This is to guarantee a consistent level of product and service quality.
- b) Manufacturers without ISO 9001:2008 certification are not acceptable.

1.7 Warranty

- a) The products will be warranted for a period of minimum two years from the date of shipment.

2.0 PRODUCT

2.1 Construction – Corrosion Resistance

STANDARD EXECUTION – GALVANIZED STEEL Z-725

- a) The complete cold water basin shall be constructed of SST 304L. The structure and all steel elements of the casing shall be constructed of Z-725 hot dip galvanized steel for long life and durability. Alternatives with lower zinc layer thickness and external paint or coating or FRP are not accepted as equal.
- b) The strainer shall be made of stainless steel type 304L.
- c) During fabrication all panel edges shall be coated with a 95% pure zinc compound.
- d) Casing materials shall be of non flammable construction.

OPTIONAL EXECUTION – BASIN IN SST 304L

- a) The structure and all steel elements of the pan up to the water level shall be made of SST 304L.
- b) Alternatives with hot dip galvanized steel and epoxy coatings in lieu of the SST 304 are not considered equal and will not be accepted.
- c) All other steel components and the casing shall be constructed of Z-725 hot dip galvanized steel for long life and durability. Alternatives with lower zinc layer thickness and external paint or coating are not accepted as equal.
- d) The strainer shall be made of stainless steel type 304L.
- e) During fabrication all galvanized steel panel edges shall be coated with a 95 % pure zinc compound.
- f) Casing materials shall be of non flammable construction.

OPTIONAL EXECUTION – COMPLETE UNIT IN STAINLESS STEEL SST 304L (except moving parts and heat exchanger coils)

- a) The structure and all steel elements shall be made of SST 304L.
- b) Alternatives with hot dip galvanized steel and epoxy coatings to replace the SST 304L are not considered equal and accepted.
- c) Casing materials shall be of non flammable construction.

2.2 Construction – Seismic and wind load resistance

- a) The structural design must withstand 1g seismic or 6.94 kN/m² wind loads.
- b) Cooling Towers must be independently certified according to IBC 2012.

2.3 Pan / Fan section

- a) The pan – fan section shall include fans and drives mounted and aligned in the factory. These items shall be located in the dry air stream.
- b) Standard pan accessories shall included circular access doors, strainer(s) of anti vortex design, brass make up valve with unsinkable, foam filled plastic float arranged for easy adjustment.
- c) The basin bottom shall be sloped to provide drainage of the complete basin section.

2.4 Mechanical Equipment

2.4.1 Fan(s)

- a) Fans shall be dynamically balanced forwardly curved centrifugal type fans.
- b) Fan housings shall have curved inlet rings for efficient air entry and rectangular discharge cowls which extend into the basin to increase fan efficiency and to prevent water from splashing into the fans.
- c) Curved inlet rings shall be made of the same material as the evaporative condenser.
- d) All fans will undergo a dry running test in the factory after being installed in the evaporative condenser basin.
- e) The fans will be mounted on either a solid shaft with forged bearing journals.
- f) Easy to remove fan screens shall be provided to avoid direct contact with the moving parts.

2.4.2 Bearings and Drive

- a) The fan shaft(s) shall be supported by heavy duty, self aligning pillow block bearings with cast iron housings and lubrication fittings for maintenance.
- b) The fan drives shall be V belt type with taper lock sheaves designed for 150% of the motor nameplate horsepower.
- c) The bearings shall be rated for an L-10 life of 40,000 hours.

2.4.3 Motor

- a) The fan motor shall be Totally Enclosed, Fan Cooled (TEFC), squirrel cage, ball bearing type motor.
- b) The motor shall be minimum IP 55 degree of protection, Class F insulation, Service Factor 1 and selected for the appropriate evaporative condenser duty and the correct ambient temperature but minimum 40°C.
- c) Motor bearings shall be greased for life or external grease lines shall be provided.
- d) The motor shall be mounted on an adjustable heavy duty steel motor base.
- e) The motor selection shall be selected for the appropriate external static pressure.
- f) The motor power supply shall be _____ volts, _____ Hertz and _____ Phase.

SPECIFICATIONS

LRC

2.5. Casing Section

2.5.1 Heat Transfer Coil

- The evaporative condenser shall use internally enhanced heat exchange coils of an elliptical tube design to obtain lower air flow resistance and allow higher water loadings around the tubes.
- The heat transfer coil(s) shall be made of all prime surface, encased in a steel framework and hot dip galvanized after fabrication as a complete assembly.
- The tubes shall be arranged in a self spacing, staggered pattern in the direction of air flow for maximum heat transfer efficiency and minimum pressure drop.
- The heat exchange coils shall be air pressure tested under water.
- The design and manufacturing process shall be approved and in accordance with the "Pressure Equipment Directive" – PED 97 / 23 EC.
- The manufacturer shall be responsible for the manufacturing and performance testing of the entire heat transfer coil. This is to assure single source responsibility.
- The casing shall totally encase the complete coil section to protect the complete coil from direct atmospheric contact.
- The pressure drop of the process fluid through the coil shall not exceed ___ kPa.

OPTIONAL - Heat Transfer Coil in SST 304L

- The evaporative condenser shall use heat exchange coils of an elliptical tube design to obtain lower air flow resistance and allow higher water loadings around the tubes.
- The heat transfer coil(s) shall be made of SST 304L encased in an SST 304L framework and passivated after fabrication as a complete assembly.
- The tubes shall be arranged in a self spacing, staggered pattern in the direction of air flow for maximum heat transfer efficiency and minimum pressure drop.
- The heat exchange coils shall be air pressure tested under water.
- The design and manufacturing process shall be approved and in accordance with the "Pressure Equipment Directive" – PED 97 / 23 EC.
- The manufacturer shall be responsible for the manufacturing and performance testing of the entire heat transfer coil. This is to assure single source responsibility.
- The casing shall totally encase the complete coil section to protect the complete coil from direct atmospheric contact.
- The pressure drop of the process fluid through the coil shall not exceed ___ kPa.

2.5.2 Water Distribution

- The spray header and branches shall be constructed of Schedule 40, Polyvinyl Chloride (PVC) pipe for corrosion resistance and shall have a steel connection to attach the external piping.
- The internal tower water distribution piping shall be easily removable for cleaning purposes.
- The water shall be distributed over the fill by precision molded ABS spray nozzles with large minimum 1 inch orifice openings and integral sludge ring to eliminate clogging.
- The nozzles shall be threaded into the water distribution piping to assure positive positioning.
- Each cell shall have only one hot water return inlet, otherwise the evaporative condenser manufacturer shall provide the necessary extra provisions (piping, balancing valves,...) to achieve the same at no extra cost.

2.5.3 Drift Eliminators

- The drift eliminators shall be constructed entirely inert polyvinyl (PVC) that has been specially treated to resist ultra violet light.
- Assembled in easily handled sections, the eliminator blades shall be spaced on 1 inch centers and shall incorporate three changes in air direction to assure efficient removal of entrained moisture from the discharge air stream.
- The maximum drift rate shall not exceed 0,001% of the recirculated water rate.
- The Drift Eliminators' performance shall be certified according to Eurovent Standard OM-14-2009.

2.6 Sound Levels

The maximum sound pressure levels (dB) as per CTI ATC 128 measured 15 m from the evaporative condenser operating at full fan speed shall not exceed the sound levels detailed below.

Location	63Hz	125Hz	250Hz	500Hz	1000Hz	2000Hz	4000Hz	8000Hz	dB(A)
Fan Discharge									
Air inlet/end									

3.0 ACCESSORIES (optional)

3.1 Electric Heaters

- The evaporative condenser cold water basin shall be provided with a electric heater package to prevent freezing of the water in the cold water basin.
- The electric heater package includes: electric heater elements and a combination of thermostat and low water level cutoff.
- The heaters shall be selected to maintain 4°C basin water temperature at ___°C ambient.
- The heater(s) shall be ___V / ___ phase / ___ Hz electric power supply.

3.2 Three Probe Electric Water Level Control Package

- The evaporative condenser manufacturer shall provide an electric water level control package instead of the mechanical float valve arrangement.
- The package consist of the following elements:
 - Multiple heavy duty stainless steel SST 316 static probes mounted in a stilling chamber outside the unit. Electrodes or sensors mounted inside the unit are not accepted because the functionality will be disturbed by the moving water in the basin.
 - An ABS, IP 56 case contains all the contactors for the different level probes and will provide an output signal for automatic filling and a level alarm.
 - The power supply to the control package is 24 Vac / 230 Vac - ___ Hz.
 - A weather protected solenoid valve (PN16) for the water make up ready for piping to a water supply with pressure between 140 kPa and 340 kPa.

3.3 Intake Sound Attenuation

- The unit will be equipped with intake sound attenuation consisting of a hot dip galvanized steel housing of the same quality of the unit and completed with acoustical baffles made of fiberglass material which is suitable for use in evaporative condensers.
- The intake sound attenuator is provided with large access doors which allow access to maintain the fans and bearings.
- Evaporative condenser motor size must be adjusted for the additional static pressure drop caused by the sound attenuator.

3.4 Discharge Sound Attenuation

- The unit will be equipped with discharge sound attenuation consisting of a hot dip galvanized steel housing of the same quality of the unit and completed with acoustical baffles made of fiberglass material which is suitable for use in evaporative condensers.
- The discharge sound attenuator is provided with large access doors which allow access to maintain the water distribution system and the drift eliminators without removing the baffles.
- The evaporative condenser motor size must be adjusted for the additional static pressure drop caused by the sound attenuator.

3.5 Vibration Switch

- A vibration limit switch shall be installed on the mechanical equipment support and wired into the control panel. The purpose of this switch will be to interrupt power the motor in the event of excessive vibration.
- The switch shall be adjustable for sensitivity, and shall require manual reset.



World Headquarters/
Research and
Development Center

EVAPCO Manufacturing
Locations

EVAPCO, Inc. - World Headquarters & Research / Development Center

P.O. Box 1300 • Westminister, MD 21158 USA
Ph: +1 410-756-2600 • Fx: +1 410-756-6450 • marketing@evapco.com

North America

EVAPCO, Inc.
World Headquarters
P.O. Box 1300
Westminster, MD 21158 USA
Ph: 410-756-2600 - Fx: 410-756-6450
marketing@evapco.com

EVAPCO East
5151 Allendale Lane
Taneytown, MD 21787 USA
Ph: 217-923-3431 - Fx: 217-923-3300
marketing@evapco.com

EVAPCO Midwest
1723 York Road
Greenup, IL 62428 USA
Ph: 217-923-3431 - Fx: 217-923-3300
evapcomw@evapcomw.com

EVAPCO West
1900 West Almond Avenue
Madera, CA 93637 USA
Ph: 559-673-2207 - Fx: 559-673-2378
contact@evapcowest.com

EVAPCO Iowa
925 Quality Drive
Lake View, IA 51450 USA
Ph: 712-657-3223 - Fx: 712-657-3226

**EVAPCO Iowa
Sales & Engineering**
215 1st Street, NE
P.O. Box 88
Medford, MN 55049 USA
Ph: 507-446-8005 - Fx: 507-446-8239
evapcomn@evapcomn.com

EVAPCO Newton
701 East Jourdan Street
Newton, IL 62448 USA
Ph: 618-783-3433 - Fx: 618-783-3499
evapcomw@evapcomw.com

EVAPCOLD
521 Evapco Drive
Greenup, IL 62428 USA
Ph: 217-923-3431
evapcomw@evapcomw.com

EVAPCO-BLCT Dry Cooling, Inc.
981 US Highway 22 West
Bridgewater, NJ 08807 USA
Ph: 1-908-379-2665
info@evapco-blct.com

**Refrigeration Valves &
Systems Corporation**
A wholly owned subsidiary of EVAPCO, Inc.
1520 Crosswind Dr.
Bryan, TX 77808 USA
Ph: 979-778-0095 - Fx: 979-778-0030
rvs@rvscorp.com

Evapco Northwest
5775 S.W. Jean Road, Suite 104
Lake Oswego, OR 97035 USA
Ph: 503-639-2137 - Fx: 503-639-1800

EvapTech, Inc.
A wholly owned subsidiary of EVAPCO, Inc.
8331 Nieman Road
Lenexa, KS 66214 USA
Ph: 913-322-5165 - Fx: 913-322-5166
marketing@evaptechinc.com

Tower Components, Inc.
A wholly owned subsidiary of EVAPCO, Inc.
5960 US HWY 64E
Ramseur, NC 27316
Ph: 336-824-2102 - Fx: 336-824-2190
mail@towercomponentsinc.com

South America

**Evapco Brasil
Equipamentos Industriais Ltda**
Rua Alexandre Dumas 1601
04717-004 Sao Paulo - SP - Brazil
Ph: (55) 19-5681-2000

Europe

**EVAPCO Europe BVBA
European Headquarters**
Heersterveldweg 19, Industrieterrein Oost
3700 Tongeren, Belgium
Ph: (32) 12-395029 - Fx: (32) 12-238527
evapco.europe@evapco.be

EVAPCO Europe, S.r.l.
Via Ciro Menotti 10
I-20017 Passirana di Rho, Milan, Italy
Ph: (39) 02-939-9041 - Fx: (39) 02-935-0084
evapcoeuropa@evapco.it

EVAPCO Europe, S.r.l.
Via Dosso 2
23020 Piateda Sondrio, Italy

EVAPCO Europe, GmbH
Insterburger Straße, 18
D-40670 Meerbusch, Germany
Ph: (49) 2159-69560 - Fx: (49) 2159-695611
info@evapco.de

Flex Coil a/s
A wholly owned subsidiary of EVAPCO, Inc.
Knøsgårdvej 115
9440 Aabybro, Denmark
Ph: (45) 9824-4999 - Fx: (45) 9824-4990
flexcoil@flexcoil.dk

EVAPCO S.A. (Pty.) Ltd.
A licensed manufacturer of Evapco, Inc.
18 Quality Road
Isando 1600, Republic of South Africa
Ph: (27) 11 392-6630 - Fx: (27) 11-392-6615
evapco@evapco.co.za

Evap Egypt Engineering Industries Co.
A licensed manufacturer of Evapco, Inc.
5 Al Nasr Road St.
Nasr City, Cairo, Egypt
Ph: (20) 2-24022866 / (20) 2-24044997/8
Fx: (20) 2-404-4667 / Mob: (20) 12-3917979
primacool@link.net / shady@primacool.net

Asia/Pacific

**EVAPCO China
Asia/Pacific Headquarters**
1159 Luoning Rd. Baoshan Industrial Zone
Shanghai, P. R. China, Postal Code: 200949
Ph: (86) 21-6687-7786 - Fx: (86) 21-6687-7008
marketing@evapcochina.com

**Evapco (Shanghai) Refrigeration
Equipment Co., Ltd.**
1159 Luoning Rd., Baoshan Industrial Zone
Shanghai, P.R. China, Postal Code: 200949
Ph: (86) 21-6687-7786 - Fx: (86) 21-6687-7008
marketing@evapcochina.com

**Beijing EVAPCO Refrigeration
Equipment Co., Ltd.**
Yan Qi Industrial Development District
Huai Rou County
Beijing, P.R. China, Postal Code: 101407
Ph: (86) 10 6166-7238 - Fx: (86) 10 6166-7395
evapcobj@evapcochina.com

EVAPCO Australia Pty Ltd.
34-42 Melbourne Road - P.O. Box 436
Riverstone, N.S.W. Australia 2765
Ph: (61) 29 627-3322 - Fx: (61) 29 627-1715
sales@evapco.com.au

EvapTech Composites Sdn. Bhd
No. 70 (Lot 1289) Jalan Industri 2/3
Rawang Integrated Industrial Park
Rawang, Selangor, 48000 Malaysia
Ph: 60 3 6092-2209 - Fx: 60 3 6092-2210

EvapTech Asia Pacific Sdn. Bhd
A wholly owned subsidiary of EvapTech, Inc.
IOI Business Park, 2/F Unit 20
Persiaran Puchong Jaya Selatan
Bandar Puchong Jaya,
47170 Puchong, Selangor, Malaysia
Ph: +(60-3) 8070 7255 - Fx: +(60-3) 8070 5731
marketing-ap@evaptech.com



EVAPCO... Specialists in Heat Transfer Products and Services.
Visit EVAPCO's Websites at: www.evapco.eu / www.mrgoodtower.eu

